



CATÁLOGO 2024

INCCO

Make The World In Your Hands

HERRAMIENTA ELÉCTRICA

CATÁLOGO 2024

ATORNILLADOR 4V COD 1001

CSDLI0442 PVP: 19,92 €

- Anclaje exagonal de 1/4"
- Reversible
- Linterna LED integrada
- Mango ajustable dos posiciones
- Incluye 16 puntas de atornillar 25mm
- Incluye 2 puntas de atornillar 50mm
- Incluye portapuntas de 1/4"
- Cargador tipo C no incluido



EAN	6976051783046	20 unid.
Voltaje	4V	
Velocidad	240rpm	
Par	4Nm	
Inserción	1/4"	

ATORNILLADOR 8V COD 1002

CSDLI0802 PVP: 41,02 €

- Anclaje exagonal de 1/4"
- Reversible
- Linterna LED integrada
- Mango ajustable dos posiciones
- Incluye 10 puntas de atornillar 25mm
- Incluye 4 brocas 1/4"
- Incluye portapuntas de 1/4"
- Cargador tipo C no incluido



EAN	6976051780700	20 unid.
Voltaje	8V	
Velocidad	220rpm	
Par	6Nm	
Inserción	1/4"	

TALADRO ATORNILLADOR PERCUTOR 12V COD 1003

CIDLI12202E PVP: 70,22 €

- Batería 1,5Ah
- Posiciones Par: 18+1+1
- Linterna Led integrada
- Maleta transporte
- Conector carga tipo C
- Cargador tipo C no incluido



EAN	6976051785316	5 unid.
Voltaje	12V	
Velocidades	0-400 0-1500	
Par	20Nm	
Portabrocas	0,8-10mm	
Percutor	22.500gpm	

TALADRO ATORNILLADOR PERCUTOR 20V COD 1004

CIDLI201455 PVP: 50,78 €

- Reversible
- Portabrocas metálico con bloqueo
- Posiciones Par: 18+1+1
- Linterna Led integrada
- No incluye cargador ni baterías



EAN	6976051787969	5 unid.
Voltaje	20V	
Velocidades	0-400 0-1500	
Par	45Nm	
Portabrocas	0,8-10mm	
Percutor	22.500gpm	

TALADRO ATORNILLADOR PERCUTOR 20V COD 1005

CIDLI201452E PVP: 125,24 €

- Reversible
- Portabrocas metálico con bloqueo
- Posiciones Par: 18+1+1
- Linterna Led integrada
- Incluye 2 baterías de 2Ah y cargador
- Incluye maleta transporte



EAN	6976051786245	5 unid.
Voltaje	20V	
Velocidades	0-400 0-1500	
Par	45Nm	
Portabrocas	0,8-10mm	
Percutor	22.500gpm	

TALADRO ATORNILLADOR PERCUTOR 20V COD 1006

CIDLI20602I PVP: 80,64 €

- Motor sin escobillas Brush-less
- Reversible
- Portabrocas metálico con bloqueo
- Posiciones Par: 22+1+1
- Linterna Led integrada
- No incluye cargador ni baterías



EAN	6976051787372	5 unid.
Voltaje	20V	
Velocidades	0-550 0-2000	
Par	60Nm	
Portabrocas	0-13mm	
Percutor	30000gpm	

TALADRO ATORNILLADOR PERCUTOR 20V

COD 1007

CIDLI20602

PVP: 170,00 €

P20S
IMPACT FUNCTION
60N.m
COMPACT BRUSHLESS

NEW

- Motor sin escobillas Brush-less
- Reversible
- Portabrocas metálico con bloqueo
- Posiciones Par: 22+1+1
- Linterna Led integrada
- Incluye 2 baterías de 2Ah y cargador
- Incluye maleta transporte

EAN	6976051788577	5 unid.
Voltaje	20V	
Velocidades	0-550 0-2000	
Par	60Nm	
Portabrocas	0-13mm	
Percutor	30000gpm	



PACK 3 HERRAMIENTAS 20V

COD 1014

COSLI230521

PVP: 398,00 €

- CAGLI201158
- CIRLI2017
- CRHLI202287
- 2 Baterías de 4 Ah
- Cargador
- Lata 10 discos de corte



EAN 6976051782612 1 unid.

TALADRO ATORNILLADOR PERCUTOR 20V

COD 1008

CIDLI20605

PVP: 185,00 €

P20S
IMPACT FUNCTION
70N.m
BL MOTOR

NEW

- Motor sin escobillas Brush-less
- Reversible
- Portabrocas metálico con bloqueo
- Posiciones Par: 22+1+1
- Linterna Led integrada
- Incluye 2 baterías de 2Ah y cargador
- Incluye maleta transporte

EAN	6976051782872	5 unid.
Voltaje	20V	
Velocidades	0-450 0-1900	
Par	70Nm	
Portabrocas	2-13mm	
Percutor	22500gpm	



PACK 5 HERRAMIENTAS 20V

COD 1009

CKLI2019

PVP: 473,88 €



- CAGLI201158
- CIWLI2038
- CDLI200528
- CRHLI20228
- CWLI2023
- HRRTB2015
- 2 Baterías de 4Ah
- Cargador
- Lata 10 discos de corte

EAN 6976051782162 1 unid.

ATRONILLADOR IMPACTO 20V COD 0639

CIRLI2002 PVP: 117,65 €



- Motor sin escobillas Brush-less
- Anclaje exagonal de 1/4"
- Linterna Led integrada
- Reversible
- Incluye 2 Baterías 2Ah y cargador
- Bolsa tela

EAN 6925582129311 5 unid.

Voltaje:	20V
Velocidades:	0-1300 0-2100rpm
Par:	170Nm
Impacto:	0-2.000 0-3300gpm

LLAVE IMPACTO 20V COD 1010

CIWLI2050 PVP: 189,74 €



- Motor sin escobillas Brush-less
- Anclaje 1/2"
- Linterna Led integrada
- Reversible
- Incluye 2 Baterías 4Ah y cargador
- Vasos 21-22-24
- Incluye maleta transporte

EAN 6976051788102 5 unid.

Voltaje	20V
Velocidades	0-1200 0-1800-2000rpm
Par	500Nm
Impacto	0-2400-2800 0-3300gpm

LLAVE DE CARRACA 3/8" 20V COD 1024

CDRLI2060151 PVP: 69,96 €



Battery and charger sold separately

- Inserción: 3/8"
- Incluye 3 vasos: 13,17 y 29mm
- Batería y cargador no incluidos

EAN 6976051789369 8 unid.

Voltaje	20V
Par máx:	65Nm

LLAVE IMPACTO 20V COD 1011

CIWLI2085 PVP: 246,68 €



- Motor sin escobillas Brush-less
- Anclaje 1/2"
- Linterna Led integrada
- Reversible
- Incluye 2 Baterías 4Ah y cargador
- Vasos 22-24-27
- Incluye maleta transporte

EAN 6976051789260 4 unid.

Voltaje	20V
Velocidades	0-1600 0-2100-2400rpm
Par	850Nm
Impacto	0-1500 0-1800 0-2200gpm

MARTILLO COMBINADO 20V COD 0358

CRHLI20168 PVP: 89,00 €



- Reversible
- Portabrocas SDS-PLUS
- Brocas 6-8-10mm incluidas
- Linterna Led integrada
- No incluye cargador ni batería

EAN 6976051789680 4 unid.

Voltaje	20V
Velocidades	0-850
Energía impacto	1,5J
Función percutor	0-5100gpm

MARTILLO COMBINADO DEMOLEDOR 20V COD 1038

CRHLI20208 PVP: 97,05 €



- Reversible
- Portabrocas SDS-PLUS
- Brocas 6-8-10mm incluidas
- Linterna Led integrada
- No incluye cargador ni baterías

EAN 6976051782995 4 unid.

Voltaje	20V
Velocidades	0-850
Energía impacto	1,5J
Función percutor	0-5100gpm

MARTILLO COMBINADO DEMOLEDOR 20V COD 0531

CRHLI20228 PVP: 131,68 €



- Motor sin escobillas Brush-less
- Reversible
- Función demoledor
- Portabrocas SDS-PLUS
- Brocas y cinceles
- Linterna Led integrada
- No incluye cargador ni batería

EAN 6941640169723 4 unid.

Voltaje	20V
Velocidades	0-1100
Energía impacto	2,5J
Función percutor	0-5000gpm

MARTILLO COMBINADO 20V COD 1306

CRHLI201681E PVP: 127,15 €

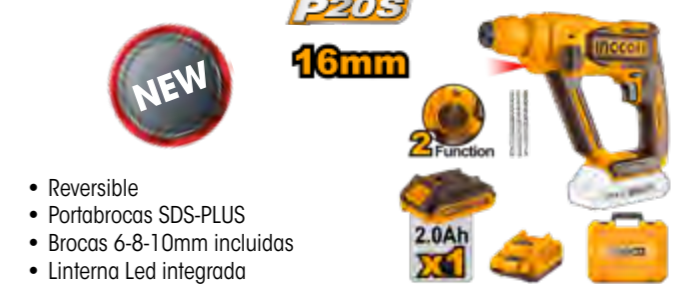

- Reversible
- Portabrocas SDS-PLUS
- Brocas 6-8-10mm incluidas
- Linterna Led integrada
- Incluye cargador y 1 batería de 2Ah
- Malefín de transporte

EAN 6942141806308 4 unid.

Voltaje	20V
Velocidades	0-850
Energía impacto	1,5J
Función percutor	0-5100gpm

MARTILLO COMBINADO DEMOLEDOR 20V COD 1013

CRHLI202081 PVP: 170,78 €



- Motor sin escobillas Brush-less
- Reversible
- Función demoledor
- Portabrocas SDS-PLUS
- Brocas y cinceles
- Linterna Led integrada
- Incluye cargador y 1 batería de 4Ah
- Malefín de transporte

EAN 6976051782926 4 unid.

Voltaje	20V
Velocidades	0-1100
Energía impacto	2,0J
Función percutor	0-5400gpm

MARTILLO COMBINADO DEMOLEDOR 20V COD 1000

CRHLI202287 PVP: 316,00 €



- Motor sin escobillas Brush-less
- Reversible
- Función demoledor
- Portabrocas SDS-PLUS
- Brocas y cinceles
- Linterna Led integrada
- Incluye cargador y 2 baterías de 4Ah
- Malefín de transporte

EAN 6941640160119 4 unid.

Voltaje	20V
Velocidades	0-1100
Energía impacto	2,5J
Función percutor	0-5000gpm

MARTILLO COMBINADO DEMOLEDOR 20V

CRHLI20288

COD 1015

PVP: 148,60 €



P20S

28mm

BL MOTOR

- Motor sin escobillas Brush-less
- Reversible
- Función demoledor
- Portabrocas SDS-PLUS
- Brocas y cinceles
- Linterna Led integrada
- No incluye cargador ni baterías



3 Function

Battery and charger sold separately



EAN 6976051782674 4 unid.

Voltaje	20V
Velocidades	0-930
Energía impacto	4,5J
Función percutor	0-4400gpm

MARTILLO COMBINADO DEMOLEDOR 20V

CRHLI202882

COD 1016

PVP: 284,62 €



P20S

28mm

BL MOTOR

- Motor sin escobillas Brush-less
- Reversible
- Función demoledor
- Portabrocas SDS-PLUS
- Brocas y cinceles
- Linterna Led integrada
- Incluye cargador y 2 baterías de 4Ah
- Maletín de transporte



3 Function

4.0Ah x2

EAN 6976051782940 2 unid.

Voltaje	20V
Velocidades	0-930
Energía impacto	4,5J
Función percutor	0-4400gpm

AMOLADORA ANGULAR 20V

CAGLI211156

COD 1017

PVP: 82,76 €



P20S BL MOTOR

- Motor sin escobillas
- Interruptor "hombre muerto"
- No incluye cargador ni baterías



115mm Battery and charger sold separately

EAN 6976051784326 4 unid.

Voltaje	20V
Velocidad	3000/8000rpm
Diámetro de disco	115mm

AMOLADORA ANGULAR 20V

CAGLI201258

COD 0741

PVP: 81,30 €

P20S BL MOTOR

- Motor sin escobillas
- No incluye cargador ni baterías



125mm Battery and charger sold separately

EAN 6941640174291 6 unid.

Voltaje	20V
Velocidad	3000/8500rpm
Diámetro de disco	125mm

SIERRA CIRCULAR 20V

CSLI1851

COD 1020

PVP: 117,74 €



P20S BL MOTOR

185mm

Battery and charger sold separately



- Motor sin escobillas
- Inclinable a 45°
- Profundidad regulable 0-65mm

EAN 6976051784111 4 unid.

Voltaje	20V
Velocidad:	4800rpm
Diámetro disco:	185mx20mm

AMOLADORA ANGULAR 20V

CAGLI2111561

COD 1018

PVP: 163,18 €



P20S BL MOTOR

- Motor sin escobillas
- Interruptor "hombre muerto"
- Incluye cargador 1 batería de 4Ah
- Lata de 10 discos de corte 115mm
- Maletín transporte



115mm x10 4.0Ah x1

EAN 6976051784333 4 unid.

Voltaje	20V
Velocidad	3000/8000rpm
Diámetro de disco	115mm

SIERRA CIRCULAR 20V

CSLI1402

COD 1019

PVP: 79,70 €



P20S BL MOTOR

140mm

Battery and charger sold separately

- Motor sin escobillas
- Inclinable a 45°
- Profundidad regulable 0-50mm



EAN 6976051789239 4 unid.

Voltaje	20V
Velocidad	6300rpm
Diámetro disco	140mmx20mm

SIERRA SABLE 20V

CRSLI1152

COD 0357

PVP: 122,43 €

Battery and charger sold separately

- Hoja metal y madera



EAN 6941640165480 4 unid.

Voltaje	20V
Velocidades	0 - 3.200 rpm
Capacidad de corte	Metal: 8mm Madera: 115mm
Amperios	2Ah/4Ah/5Ah

SIERRA DE CALAR 20V COD 0359

CJSLI8501 PVP: 92,44 €



Battery and charger sold separately

- No incluye cargador ni batería
- Blister hojas madera.
- Caja cartón INGCO

EAN	6925582130003	5 unid.
Voltaje	20V	
Velocidad	0 - 2.900 rpm	
Capacidad de corte	10 mm - metal	
	85 mm madera	
Amperios	2Ah/4Ah/5Ah	

LIJADORA MOUSE 20V COD 0745

CDSL2051 PVP: 48,00 €



Battery and charger sold separately

- No incluye cargador ni batería
- Aspiración integrada
- Caja cartón INGCO
- Incluye 5 lijas

EAN	6941640161734	8 unid.
Voltaje	20V	
Velocidades	10.000 rpm	
Amperios	2Ah/4Ah/5Ah	
Diámetro	125 mm	

PISTOLA AIRE CALIENTE 20V COD 1022

HGLI2002 PVP: 41,18 €



Battery and charger sold separately

- Incluye 3 toberas
- Batería y cargador no incluidos

EAN	6941640181688	10 unid.
Voltaje	20V	
Temperatura	300/550°	
Caudal aire	100/200lts/min	

LIJADORA MANO 20V COD 1021

CSHSLI2014 PVP: 33,80 €



Battery and charger sold separately

- Base: 110x100mm
- No incluye cargador ni batería
- 5 pcs lijas 110x100mm

EAN	6976051787365	12 unid.
Voltaje	20V	
Velocidad	12.000 rpm	
Par	110x100 mm	

LIJADORA ROTO-ORBITAL 20V COD 0517

CROSLI2001 PVP: 80,62 €



Battery and charger sold separately

- No incluye cargador ni batería
- Aspiración integrada
- Caja cartón INGCO
- Incluye 5 lijas

EAN	6925582134469	4 unid.
Voltaje	20V	
Velocidad	10.000 rpm	
Amperios	2Ah/4Ah/5Ah	
Diámetro	125 mm	

MULTI-HERRAMIENTAS 20V COD 0360

CMLI2022 PVP: 43,26 €



Battery and charger sold separately

- Accesorios incluidos.
- No incluye cargador ni batería
- Caja cartón INGCO

EAN	6976051784197	8 unid.
Voltaje	20V	
Velocidades	5.000 - 20.000 rpm	
Amperios	2Ah/4Ah/5Ah	

PISTOLA PINTAR 20V COD 0361

CSGLI2001 PVP: 68,22 €



Battery and charger sold separately

- No incluye cargador ni batería
- Caja cartón INGCO

EAN	6925582128376	8 unid.
Voltaje	20V	
Viscosidad máxima	40 DIN-s	
Pulverización máxima	600 MI/min	
Depósito	800 MI	
Amperios	2Ah/4Ah/5Ah	

CLAVADORA 35MM 20V COD 1023

CBNLI3505 PVP: 159,38 €



Battery and charger sold separately

- Para clavos: ANA18201, ANA18251, ANA18301, ANA18351
- Batería y cargador no incluidos

EAN	6941640185839	6 unid.
Voltaje	20V	
Capacidad clavado	3 clavos por segundo	
Capacidad depósito	105 puntas	

CLAVADORA AGUJAS PIN COD 1039

CBNLI3603 PVP: 182,16 €



Battery and charger sold separately

- Para agujas de 0,64mmx25mm ANA06825
- Batería y cargador no incluido
- Maleta incluida

EAN	6942141802782	4 unid.
Voltaje	20V	
Capacidad clavado:	3 clavos por segundo	
Capacidad depósito:	140 puntas	

COMPRESOR AIRE 20V COD 0363

CACLI2001 PVP: 50,30 €



Battery and charger sold separately

- Incluye 3 toberas
- Batería y cargador no incluidos

EAN	6925582128086	4 unid.
Voltaje	20V	
Presión máxima	11 Bar	
Amperios	2Ah/4Ah/5Ah	

CLAVADORA 50MM 20V COD 0751

CBNLI2016 PVP: 254,96 €



Battery and charger sold separately

- Incluye cargador y 1 batería de 20 V 2,0 Ah
- Tipo de clavo: F15-F50
- Adecuado para: ANA18201, ANA18251, ANA18301, ANA18351, ANA18401, ANA18501
- Caja cartón INGCO

EAN	6941640184078	5 unid.
Voltaje	20V	
Velocidad máx	2,5 clavos/seg	
Capacidad	100 clavos	
Presión	8 Bar máx.	

PISTOLA COLA TERMOFUSIBLE 20V COD 0752

CGGLI2001 PVP: 22,00 €



Battery and charger sold separately

- Con 3 barras de pegamento de 150 mm.
- NO incluye batería ni cargador
- Envasado en doble blister

EAN	6925582130010	36 unid.
Voltaje	20V	
Capacidad de encendido	15-18 gr/min	
Diámetro barra cola	11,2 mm	
Tiempo calentamiento	60 sg	

ASPIRADOR 20V COD 0545

CVLI2001 PVP: 74,34 €



Battery and charger sold separately

- No incluye cargador ni batería
- Accesorios incluidos
- Caja cartón INGCO

EAN	6925582139150	4 unid.
Voltaje:	20V	
Presión de vacío	7 KPA	
Depósito	0,7 L	
Diámetro de disco	165 mm	
Amperios	2Ah/5Ah	

SOPLADOR 20V COD 1025

CABLI20028 PVP: 22,41 €



P20S **2.7m³/min**

Battery and charger sold separately

- Máximo volumen aire: 2,7m³/min
- Batería y cargador no incluidos

NEW

EAN	6976051786757	1 unid.
Voltaje	20V	
Velocidad	18000 rpm	

FOCO 20V COD 0364

CWLI2025 PVP: 39,86 €



P20S **900 Lumens**

Battery and charger sold separately

- 1800/900 lumens
- Rotación 360°
- No incluye cargador ni batería

EAN	6941640158994	6 unid.
Voltaje	20V	
Potencia	20W	

SIERRA NANOBLADE 20V COD 0642

CGSLI2068 PVP: 131,67 €



P20S **BL MOTOR** **6"**

Battery and charger sold separately

- Motor sin escobillas
- No incluye cargador ni batería
- Voltaje 20V
- Espada 6"
- Capacidad de corte 120mm
- Amperios 2 Ah / 4 Ah / 5 Ah

EAN	6941640156518	5 unid.
Voltaje	20V	
Longitud espada	15 cm	
Velocidad de la cadena	11 m/s	

LINTERNA 20V COD 0362

CWLI2001 PVP: 36,50 €



P20S

Battery and charger sold separately

- No incluye cargador ni batería
- Caja cartón INGCO

EAN	6925582129878	12 unid.
Voltaje	20 V	
Amperios	2Ah/4Ah/5Ah	
Potencia	3,2 W	
Lumens	225	

SIERRA NANOBLADE 20V COD 1026

CGSLI2058 PVP: 44,78 €



P20S **5"**

Battery and charger sold separately

- Longitud espada: 13cm
- Capacidad de corte: 100mm
- No incluye cargador ni baterías

NEW

EAN	6976051782421	6 unid.
Voltaje	20V	

MOTOSIERRA CADENA 20V COD 0754

CGSLI20128 PVP: 169,29 €



P20S **BL MOTOR** **12"**

Battery and charger sold separately

- Motor sin escobillas
- La batería y el cargador se venden por separado
- Caja cartón INGCO

EAN	6941640163868	2 unid.
Voltaje	20V	
Longitud espada	30 cm	
Velocidad de la cadena	7,9 m/s	

ESPADA MOTOSIERRA COD 0762

AGSB51201 PVP: 14,24 €



12"

- Espada para motosierra 12" 300mm
- Adecuado para motosierras: CGSLI2001
- CGSLI20128 CGSLI201286
- UCGSLI201286

EAN	6941640156488	25 unid.
-----	---------------	----------

TIJERA PODA 20V COD 0755

CSSLI203083 PVP: 189,75 €



P20S **BL MOTOR**

Battery and charger sold separately

- Motor sin escobillas
- Incluye 1 batería 2.0Ah y cargador.
- Maleta transporte BMC

NEW

EAN	6941640164889	6 unid.
Voltaje	20V	
Diámetro de corte	20 mm/30 mm	

DESBROZADORA 20V COD 0757

CSTLI20018 PVP: 276,42 €



BL MOTOR **P20S** **330mm/255mm**

Battery and charger sold separately

- Motor sin escobillas
- Dos funciones: corte de césped y corte de arbustos.
- Con 1 cabezal de corte.
- Con 1 hoja 3T.
- La batería y el cargador se venden por separado
- Caja cartón INGCO

Power and speed control

EAN	6941640148124	1 unid.
Voltaje	40 V (20V+20V)	
Velocidad sin carga	0-5000 rpm / 0-6500 rpm	
Diámetro corte	255 mm	
Diámetro hilo	2,0	
Capacidad hilo	5 mts	

CADENA MOTOSIERRA COD 0763

AGSC51201 PVP: 13,66 €



12"

- Cadena para motosierra 12" 300mm
- Adecuado para motosierras: CGSLI2001
- CGSLI20128 CGSLI201286
- UCGSLI201286

EAN	6941640169273	50 unid.
-----	---------------	----------

CORTABORDES 20V COD 0756

CGTLI20018 PVP: 65,00 €



P20S **300mm**

Battery and charger sold separately

- La batería y el cargador se venden por separado
- Caja cartón INGCO

EAN	6941640143006	2 unid.
Voltaje	20V	
Velocidad sin carga	8200 rpm	
Diámetro corte	300 mm	
Diámetro hilo	1,6	
Capacidad hilo	5 mts	

CORTASETOS 20V COD 0758

CSTLI2001 PVP: 57,06 €



P20S **Laser Cut Blade**

Battery and charger sold separately

- Cuchilla cortada con láser
- La batería y el cargador se venden por separado
- Caja cartón INGCO

EAN	6941640146199	1 unid.
Voltaje	20V	
Velocidad sin carga	2800 rpm	
Longitud de corte	460 mm	
Diámetro máximo corte	18 mm	

CORTASETOS 20V

CHTLI20018

COD 0759

PVP: 83,00 €

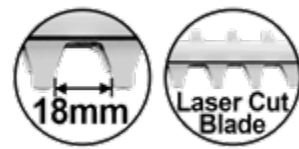

P20S



Battery and charger sold separately

- Cuchilla cortada con láser
- La batería y el cargador se venden por separado
- Caja cartón INGCO

EAN 6941640130211 6 unid.

Voltaje	20V
Velocidad sin carga	2800 rpm
Longitud de corte	460 mm
Diámetro máximo corte	18 mm

SOPLADOR JARDÍN 20V

CABLI20428

COD 0760

PVP: 99,00 €



variable speed

8.5m³/min



Battery and charger sold separately

- Motor sin escobillas
- La batería y el cargador se venden por separado.
- Caja cartón INGCO

EAN 6941640169051 2 unid.

Voltaje	20V
Velocidad motor	18500 rpm
Volúmen aire	8,5 m ³ /min
Velocidad aire	144 km/h

BATERIA LI-ON 12 V 1,5Ah

FBLI12152E

COD 0365

PVP: 22,36 €



EAN 6941640121196 10 unid.

PACK 2 BATERIAS 20V 2.0Ah + CARGADOR

FBCPK1222E

COD 1027

PVP: 74,88 €



- Pack 2 baterias 2.0AH + cargador

EAN 6976051787457 10 unid.

PACK 2 BATERIAS 20V 4.0Ah + CARGADOR

FBCPK1424

COD 1028

PVP: 124,15 €



EAN 6976051788089 10 unid.

PACK 2 BATERIAS 20V 5.0Ah + CARGADOR

FBCPK2425

COD 1029

PVP: 158,00 €



EAN 6976051786528 8 unid.

BATERIA 20V 2,0Ah

FBLI2001

COD 0367

PVP: 33,50 €



- Indicador carga led

EAN 6925582128123 20 unid.
 Voltaje 20V
 Amperios 2 Ah

BATERIA 20V 4,0Ah

FBLI2002

COD 0415

PVP: 52,30 €



EAN 6925582131505 12 unid.
 Voltaje 20V
 Diámetro de corte 4 Ah

BATERIA 20V 5,0Ah

FBLI2003

COD 0640

PVP: 79 €



- indicador carga led

EAN 6941640144478 12 unid.
 Voltaje 20V
 Amperios 5 Ah

BATERIA 20V 7,5Ah

FBLI2075

COD 0764

PVP: 109,10 €



- indicador carga led

EAN 6941640157065 12 unid.
 Voltaje 20V
 Amperios 7,5 Ah

CARGADOR USB COD 1030

FCLI120502 PVP: 4,14 €



- USB type-A

EAN	6976051789338	100 unid.
Voltaje	220-240V-50/60Hz	
Voltaje salida	5V	

CABLE CARGADOR USB TIPO C- TIPO C COD 1032

IUCC02 PVP: 1,18 €



- Cable cargador TYPE-C TYPE-C

EAN	6928073603567	120 unid.
-----	---------------	-----------

CARGADOR 20V 2Ah COD 0368

FCLI2001E PVP: 22,56 €



- Voltaje: 20 V
- Carga completa: 2 h

EAN	6925582131567	20 unid.
Amperios	2Ah/4Ah/5Ah	

CARGADOR 2 PUERTOS 20V 4Ah COD 1033

FCLI2082 PVP: 51,91 €



- Cargador de dos puertos

EAN	6976051782551	20 unid.
Voltaje	20V	

CABLE CARGADOR USB A-TYPE C COD 1031

IUCC01 PVP: 1,08 €



- Cable cargador USB A-TYPE C

EAN	6925582154795	120 unid.
-----	---------------	-----------

CARGADOR 12V COD 0366

FCLI12071E PVP: 7,18 €



EAN	6941640108487	20 unid.
-----	---------------	----------

CARGADOR 20V 4Ah COD 0548

FCLI20411E PVP: 32,28 €



- Indicador carga led

EAN	6941640177537	12 unid.
-----	---------------	----------

Voltaje	20V
Amperios	5 Ah

CARGADOR 6 PUERTOS 20V 4Ah COD 1034

FCLI2064 PVP: 57,68 €



- Cargador de seis puertos

EAN	6976051788218	6 unid.
-----	---------------	---------

Voltaje	20V
---------	-----

ADAPTADOR CARGADOR USB COD 0547

CUCLI2001 PVP: 14,76 €



- No incluye cargador ni batería
- Caja cartón INGCO
- Potencia de salida: 5v / 1A - 5v / 2A
- Batería 4Ah

EAN	6925582140941	20 unid.
-----	---------------	----------

TALADRO PERCUTOR 680W COD 0635

ID6808E PVP: 37,85 €



- Electrónico y reversible
- Caja cartón INGCO

EAN	6941640166852	5 unid.
-----	---------------	---------

Voltaje	220 - 240 V / 50 - 60 Hz
Potencia	680 W
Velocidades	0-3000 rpm
Portabrocas	13 mm
Función percutor	48000 gpm

TALADRO PERCUTOR 810W COD 0005

ID8108 PVP: 43,62 €



- Electrónico y reversible
- Función percutor

EAN	6941640136190	5 unid.
-----	---------------	---------

Voltaje	220 - 240 V / 50 - 60 Hz
Potencia	810W
Velocidades	0-2800 rpm
Portabrocas	13 mm
Función percutor	48000 gpm

TALADRO PERCUTOR 850W COD 0006

ID8508-2 PVP: 66,60 €



- Electrónico y reversible
- Caja cartón INGCO
- Portabrocas automático

EAN	6925582128130	5 unid.
-----	---------------	---------

Voltaje	220 - 240 V / 50 - 60 Hz
Potencia	850 W
Velocidades	0 - 2.700 rpm
Portabrocas	13 mm
Función percutor	43.200 gpm

TALADRO PERCUTOR 1100W COD 0007

ID11008 PVP: 70,22 €



- Electrónico y reversible
- Caja cartón INGCO
- Portabrocas automático

EAN	6928073604458	5 unid.
-----	---------------	---------

Voltaje	220 - 240 V / 50 - 60 Hz
Potencia	1.100 W
Velocidades	0 - 2.800 rpm
Portabrocas	13 mm
Función percutor	44.800 gpm

MARTILLO LIGERO 800W COD 0008

RGH9028 **800W** 26mm PVP: 89,52 €

- Peso 3 kg
- Acc: 3 brocas, puntero y cincel
- Capacidad 26mm
- Maleta transporte BMC
- SDS plus



EAN	6925582142273	2 unid.
Voltaje	220 - 240 V / 50 - 60 Hz	
Potencia	800 W	
Velocidad	0-1200 rpm	
Energía impacto	2,5 J	
Función percutor	5300 gpm	

MARTILLO COMBINADO 1500W COD 0009

RH150028 **1500W** 32mm(1-1/4") PVP: 127,14 €

- Peso: 5 kg
- Acc: Brocas 8-10-12, cincel, puntero y grasa
- SDS PLUS
- Maleta transporte BMC



EAN	6925582126495	2 unid.
Voltaje	220 - 240 V / 50 - 60 Hz	
Potencia	1.500 W	
Velocidad	850 rpm	
Capacidad	32 MM	
Energía impacto	5,5 J	
Función percutor	0 - 4.400 gpm	

MARTILLO COMBINADO 1700W COD 1036

RH1700558 **1700W** 55mm **SDS MAX** PVP: 820,00 €

- Peso: 13kg
- Regulación electrónica de la velocidad
- Electrónica constante
- Capacidad en hormigón: 55mm
- Capacidad corona: 150mm
- Sistema doble anti-vibración
- Indicador escobillas
- Accesorios: Brocas 18-22 Cincel, puntero y grasa
- SDS MAX
- Maleta transporte BMC



EAN	6976051785026	1 unid.
Voltaje	220-240 V 50-60Hz	
Potencia	1700W	
Velocidad	100-220 rpm	
Energía impacto	5-19 J	
Función percutor	1750-2150 gpm	

MARTILLO LIGERO 950W COD 1035

RGH9528 **950W** 28mm PVP: 103,80 €

- Peso: 3kg
- Accesorios: 3 Brocas Puntero + Cincel
- Capacidad hormigón: 28mm
- Maleta transporte BMC
- SDS Plus



EAN	6925582147216	4 unid.
Voltaje	220 - 240 V / 50 - 60 Hz	
Potencia	950W	
Velocidad	0-1050 rpm	
Energía impacto	2,5 J	
Función percutor	4670 gpm	

MARTILLO COMBINADO 1600W COD 0602

RH1600388 **1600W** 40mm PVP: 198,00 €

- Peso: 7,5kg
- Accesorios: Brocas 18-22 Cincel, puntero y grasa
- SDS MAX
- Maleta transporte BMC



EAN	6976051789291	2 unid.
Voltaje	220-240V 50-60Hz	
Potencia	1600W	
Velocidad	0-630 rpm	
Energía impacto	10,0 J	
Función percutor	1750-2150 gpm	

MARTILLO DEMOLEDOR 1300W COD 0416

PDB130018 PVP: 148,96 €



- Peso: 6 kg
- Acc: puntero, cincel y grasa.
- Anclaje hexagonal 17 mm
- Maleta BMC

EAN	6941640158468	2 unid.
Voltaje	220 - 240 V / 50 - 60 Hz	
Potencia	1.300 W	
Energía impacto	20 J	
Función percutor	3.800 gpm	

MARTILLO DEMOLEDOR 1700W COD 0440

PDB17008 **1700W** 16kg **SDS HEX** PVP: 309,60 €



- Peso: 16 kg
- Cable: 4 m
- Anclaje hexagonal 30 mm
- Acc: puntero, cincel
- Lubricación con aceite 15W40
- Maleta transporte BMC con ruedas

EAN	6925582106930	1 unid.
Voltaje	220 - 240 V / 50 - 60 Hz	
Potencia	1.700 W	
Energía impacto	45 J	
Función percutor	1.400 gpm	

MARTILLO DEMOLEDOR 1500W COD 0277

PDB15006 **1500W** 10.5kg PVP: 379,16 €



- Peso: 11 kg
- Acc: puntero, cincel y grasa
- SDS MAX
- Maleta transporte BMC

EAN	6925582112122	1 unid.
Voltaje	220 - 240 V / 50 - 60 Hz	
Potencia	1.500 W	
Energía impacto	6 - 25 J	
Función percutor	1.000 - 1.900 gpm	

MARTILLO DEMOLEDOR 2200W COD 0212

PDB22001 **2200W** 30kg **SDS HEX** PVP: 831,26 €



- Peso: 30 kg
- Cable: 4 m
- Anclaje hexagonal 28 mm
- Acc: Puntero, cincel, estuche llaves allen y grasa

EAN	6925582108309	1 unid.
Voltaje	220 - 240 V / 50 - 60 Hz	
Potencia	2.200 W	
Energía impacto	75 J	
Función percutor	950 gpm	

SIERRA CALAR 570W COD 0018

JS57028

PVP: 47,02 €



- Inclinación de la base: 45°
- Avance pendular
- Acc: 3 sierras.
- Caja de cartón INGCO

EAN	6925582138665	5 unid.
Voltaje	220 - 240 V / 50 - 60 Hz	
Potencia	570 W	
Velocidades	800 - 3.000 rpm	
Capacidad corte	8 mm - metal 115 mm - madera	

SIERRA SABLE 750W COD 0016

RS8008

PVP: 94,41 €



- Acc: Hoja metal y madera
- Caja cartón INGCO

EAN	6925583129298	5 unid.
Voltaje	220 - 240 V / 50 - 60 Hz	
Potencia	750 W	
Velocidades	2800 rpm	
Capacidad corte	5 mm - metal 115 mm - madera	

ENSAMBLADORA 950W COD 0015

BJ9508

PVP: 126,40 €



- Bolsa aspiración
- ACC: 15 galletas N°20
- Caja de cartón INGCO

EAN	6925582119862	4 unid.
Voltaje	220 - 240 V / 50 - 60 Hz	
Potencia	950 W	
Velocidades	11.000 rpm	
Diámetro disco	100 mm	

SIERRA CALAR 800W COD 0369

JS80028-1

PVP: 74,88 €



- Inclinación de la base: 45°
- Avance pendular
- Acc: Blister 5 hojas madera metal
- Caja de cartón INGCO

EAN	6925582136784	5 unid.
Voltaje	220 - 240 V / 50 - 60 Hz	
Potencia	800 W	
Velocidades	500 - 3.000 rpm	
Capacidad corte	10 mm - metal 110 mm - madera	

SIERRA SABLE 1200W COD 0766

RS12001

PVP: 133,22 €

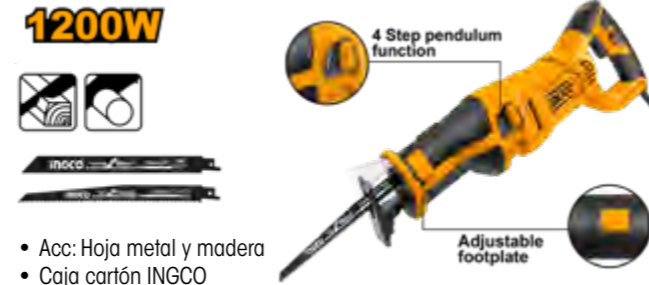

- Acc: Hoja metal y madera
- Caja cartón INGCO

EAN	6941640180025	4 unid.
Voltaje	220 - 240 V / 50 - 60 Hz	
Potencia	1200 W	
Velocidades	2800 rpm	
Capacidad corte	5 mm - metal 115 mm - madera	

MULTIHERRAMIENTAS 300W COD 0643

MF3008

PVP: 51,90 €



- 8 Accesorios incluidos
- Caja cartón INGCO

EAN	6925582127027	8 unid.
Voltaje	220 - 240 V / 50 - 60 Hz	
Potencia	300 W	
Velocidades	10000-20000 rpm	

TRONZADORA ABATIBLE 1400W COD 0028

BMS14002

PVP: 152,36 €



- Aspiración incluida
- Confeccionada en aluminio
- Base giratoria
- Cabezal inclinable

EAN	6928073603321	1 unid.
Voltaje	220 - 240 V / 50 - 60 Hz	
Potencia	1.400 W	
Velocidades	5.000 rpm	
Capacidad de corte máximo	120 x 55 mm	
Diámetro del disco	210 mm	
Diámetro del eje	25,4 mm	

CEPILLO 1050W COD 0268

PL10508

PVP: 102,10 €



- Cuchilla reversible 82 x 3 mm

EAN	6925582123333	4 unid.
Voltaje	220 - 240 V / 50 - 60 Hz	
Potencia	1.050 W	

LIJADORA MANO 240W COD 0768

PS2408

PVP: 53,43 €



- Con 5 papeles de lija (AKFS140102)
- Con 1 juego de escobillas de carbón adicionales
- Caja cartón INGCO

EAN	6925582124057	6 unid.
Voltaje	220 - 240 V / 50 - 60 Hz	
Potencia nominal	240 W	
Velocidades sin carga	11.000 rpm	

SIERRA CIRCULAR 1600W COD 0013

CS18568

PVP: 109,10 €



- Inclinable 45°
- Control profundidad
- Caja cartón INGCO

EAN	6925582126112	2 unid.
Voltaje	220 - 240 V / 50 - 60 Hz	
Potencia	1.400 W	
Velocidades	4.800 rpm	
Capacidad de corte máximo	65 mm	
Diámetro del disco	185 mm	
Diámetro del eje	20 mm	

LIJADORA MOUSE 65W COD 0769

MS6505

PVP: 53,43 €



- Con 3 hojas de lija para dedos.
- Con 6 papeles de lija
- Con 1 bolsa de polvo.
- Con 1 almohadilla para los dedos.
- Caja cartón INGCO

EAN	6941640160331	6 unid.
Voltaje	220 - 240 V / 50 - 60 Hz	
Potencia nominal	65 W	
Velocidades sin carga	11.000 rpm	

LIJADORA ORBITAL 320W COD 0213

FS3208

PVP: 52,38 €



- Base de aluminio
- Incluye 5 lijas
- Caja cartón INGCO
- (P80 3 pcs + P120 2pcs)

EAN	6925582117660	6 unid.
Voltaje	220 - 240 V / 50 - 60 Hz	
Potencia	320 W	
Velocidades	14.000 rpm	
Medida base	185 x 9 mm	

LIJADORA DE BANDA 1200W COD 0022

PBS12001 PVP: 173,41 €



- Cuerpo aluminio
- Bolsa aspiración incluida
- Caja de cartón INGCO
- Incluye 1 lija (P80)

EAN	6928073600085	2 unid.
Voltaje	220 - 240 V / 50 - 60 Hz	
Potencia	1.200 W	
Velocidades	500 m/min	
Medida banda lija	610 x 100 mm	

MEZCLADORA INDUSTRIAL 1400W COD 0210

MX214008 PVP: 124,14 €

1400W



- Incluye una paleta mezcladora
- Cuerpo y caja de cambios de aluminio
- Caja cartón INGCO

EAN	6925582135107	4 unid.
Voltaje	220 - 240 V / 50 - 60 Hz	
Potencia	1.400 W	
Medida de la mecha	M14	

ASPIRADOR INDUSTRIAL 1200W COD 0341

VC12302 PVP: 171,93 €



- 1 Pcs manguera flexible
- 1Pcs cepillo
- 1Pcs tubo de plástico
- 1Pcs filtro hefa
- Limpieza en seco y mojado
- Adaptador para herramientas eléctricas
- Embalado en caja de cartón
- Material tanque: acero inoxidable
- Depósito: 30 l
- Función soplador

EAN	6925582133837	1 unid.
Voltaje	220 - 240 V / 50 - 60 Hz	
Potencia	1.200 W	
Flujo de aire	1.9 cbm/min	
Presión de vacío	16 - 18 KPA	
Depósito	30 l acero inox	

LIJADORA ROTO-ORBITAL 450W COD 0021

RS4508 PVP: 83,88 €

450W

Ø150mm



- Caja cartón INGCO
- Base de aluminio
- Incluye 5 lijas (P80)

EAN	6925582135107	6 unid.
Voltaje	220 - 240 V / 50 - 60 Hz	
Potencia	450 W	
Velocidades	4.000 - 13.000 rpm	
Diámetro	150 mm	

SOPLADOR-ASPIRADOR 800W COD 0024

AB8008 PVP: 70,35 €



- Incluye manguera aspiración, bolsa y accesorios
- Velocidad variable

EAN	6925582123340	4 unid.
Voltaje	220-240v 50/60z	
Potencia	800W	
Velocidad	0-15000 rpm	
Aire desplazado	0-4,5m3/min	

FILTRO ASPIRADOR VC12302 COD 0342

VCAIHP02 PVP: 15,91 €



EAN	6925582123227	1 unid.
-----	---------------	---------

MINI AMOLADORA 115MM 750W COD 0441

AG75028E PVP: 55,38 €

750W

Ø115mm



- Tuerca M-14
- Caja de cartón INGCO

EAN	6941640165190	10 unid.
Voltaje	220 - 240 V / 50 - 60 Hz	
Potencia	750 W	
Velocidades	12.000 rpm	
Diámetro	115 mm	

MINI AMOLADORA 125MM 950W COD 0601

AG8528E PVP: 77,12 €



- Tuerca M-14
- Caja de cartón INGCO

EAN	6941640137258	6 unid.
Voltaje	220 - 240 V / 50 - 60 Hz	
Potencia	950 W	
Velocidades	12.000 rpm	
Diámetro	125 mm	

MINI AMOLADORA 115MM 950W COD 0033

AG8508E PVP: 74,11 €

950W

Ø115mm



- Tuerca M-14
- Caja de cartón INGCO

EAN	6925582118438	6 unid.
Voltaje	220 - 240 V / 50 - 60 Hz	
Potencia	950 W	
Velocidades	11.000 rpm	
Diámetro	115 mm	

MINI AMOLADORA 125MM 1100W COD 0644

AG110038E PVP: 59,59 €

1100W Ø125mm(5")



- Tuerca M-14

EAN	6942141800702	6 unid.
Voltaje	220-240v 50/60z	
Potencia	1100W	
Velocidad	12000 rpm	
Diámetro disco	125mm	

AMOLADORA ANGULAR 2400W
AG24008E COD 0035
PVP: 131,67 €

2400W Ø230mm



- Tuerca M-14
- Caja de cartón INGCO

EAN	6925582132267	10 unid.
Voltaje	220 - 240 V / 50 - 60 Hz	
Potencia	2.400 W	
Velocidades	6.300 rpm	
Diámetro	230 mm	

TRONZADORA PARA METALES 2400W
COS35568E COD 1037
PVP: 254,69 €

2400W
Ø355mm



- Diámetro disco: 355mm x 25,4x3mm
- Capacidad de corte:
100mm tubo redondo
100x100 tubo cuadrado
120x100 tubo rectangular

EAN	6925582145991	1 unid.
Voltaje	220 - 240 V / 50 - 60 Hz	
Potencia	2400w	
Velocidad	3900 rpm	



ROZADORA DE MUROS 1500W
WLC15008 COD 0442
PVP: 178,36 €

1500W Ø125mm



- Tuerca M-14
- Acc: 4 discos y cincel
- Caja de cartón INGCO

EAN	6925582132083	6 unid.
Voltaje	220 - 240 V / 50 - 60 Hz	
Potencia	1.500 W	
Velocidades	9.000 rpm	
Diámetro	125 mm	
Corte profundidad	3 - 29 mm	
Corte ancho	8 - 30 mm	

LIJADORA DE MUROS 1050W
DWS10501 COD 0770
PVP: 177,17 €

1050W

12PCS Sand papers
P60x2, P80x2
P120x2, P150x2
P180x2, P240x2

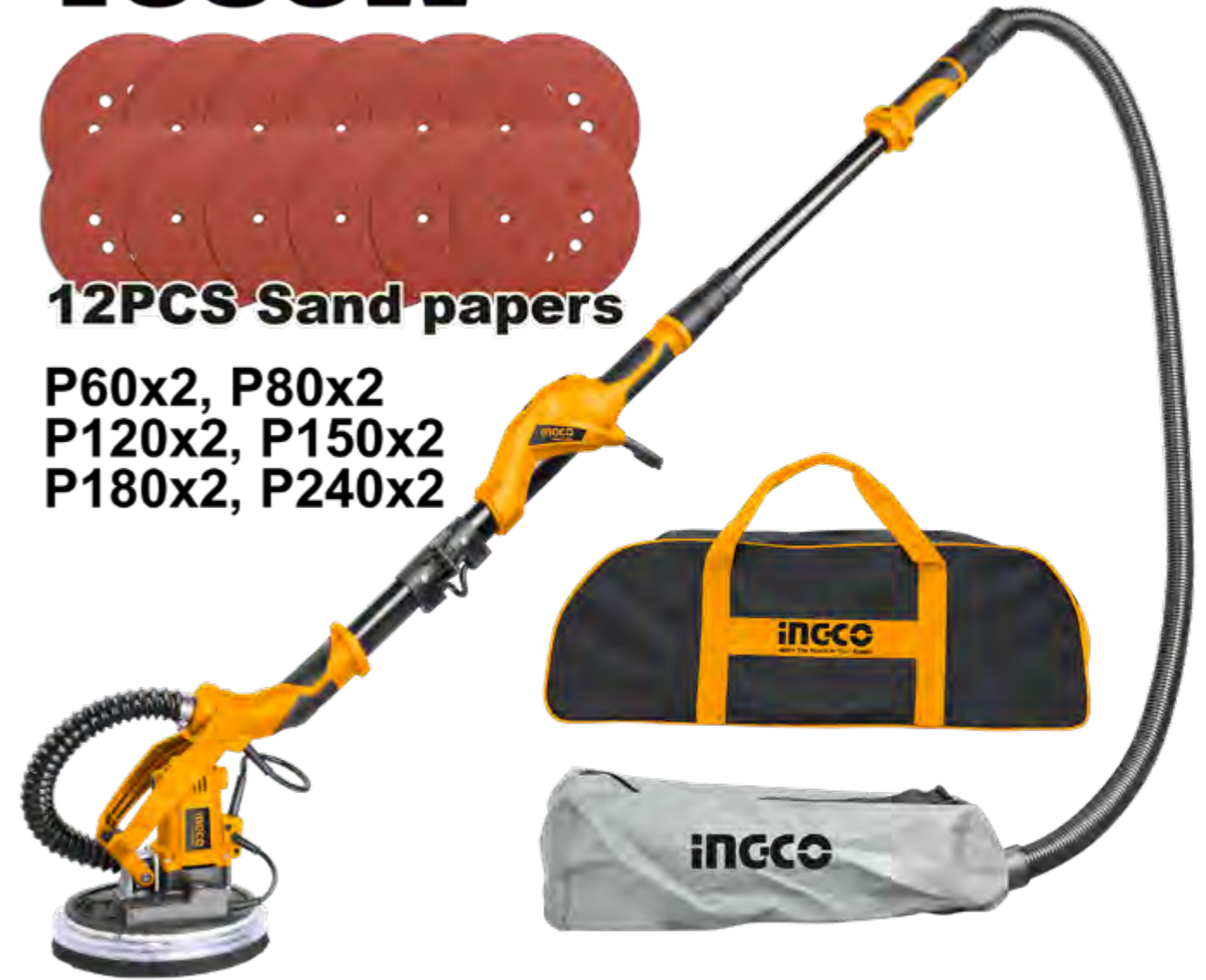

- Diámetro de la manguera de polvo: 38 mm
- Luz de trabajo integrada
- 6 papeles de lija.
- Adaptadores de conexión y tubo flexible de 4m.

- Barra de extensión 1pcs.
- 1 bolsa de polvo.
- 1 juego de escobillas de carbón adicionales.

EAN	6925582127515	1 unid.
Voltaje	220 - 240 V / 50 - 60 Hz	
Potencia	1.050 W	
Velocidad sin carga	600-2300 rpm	
Diámetro del disco	225 mm	
Diámetro de tubo	32 mm	

PISTOLA AIRE CALIENTE 2000W
HG200047 COD 0650
PVP: 39,50 €



- 5 Acc. incluidos
- Regulable en velocidad y temperatura
- Caja de cartón INGCO

EAN	6925582131154	8 unid.
Voltaje	220 - 240 V / 50 - 60 Hz	
Potencia	2.000 W	
Velocidad	200 l/min - 300 l/min - 500 l/min	
Temperatura	50 - 380 - 570 °C	

PISTOLA DIGITAL AIRE CALIENTE 2000W
HG200058 COD 1040
PVP: 52,77 €



- 4 Acc. incluido
- Regulable en velocidad y temperatura.
- Display LCD

EAN	6941640191779	1 unid.
Voltaje:	220 - 240 V / 50 - 60 Hz	
Potencia: 2.000 W	2.000 W	
Velocidad:	250 l/min - 300 l/min - 450 l/min	
Temperatura:	50 / 50-600 / 50-600 °C	

PISTOLA COLA CALIENTE 100W
GG148 COD 0651
PVP: 8,84 €



- Diámetro 11,2 mm
- 2 Recambios incluidos
- 13-18 gr/min

EAN	6941640163585	12 unid.
Voltaje	220 - 240 V / 50 - 60 Hz	
Potencia	100 W	

PISTOLA COLA CALIENTE 220W
GG308 COD 0026
PVP: 21,05 €



- Diámetro recambio 11,2 mm
- 8 Recambios incluidos
- 20 - 30 gr/min

EAN	6925582138894	4 unid.
Voltaje	220 - 240 V / 50 - 60 Hz	
Potencia	220 W	

PISTOLA PINTAR 450W
SPG3508 COD 0027
PVP: 37,26 €



- Caja de cartón INGCO

EAN	6925582125719	4 unid.
Voltaje	220 - 240 V / 50 - 60 Hz	
Potencia	450 W	
Depósito	800 ml	
Diámetro boquilla	2,5 mm	
Pulverización	380 ml/min	
Densidad máx	50 DIN-s	

PISTOLA PINTAR CON TURBINA 550W
SPG5008-2 COD 0652
PVP: 53,03 €



- Caja de cartón INGCO

EAN	6925582126235	4 unid.
Voltaje	220 - 240 V / 50 - 60 Hz	
Potencia	550W	
Deposito	800 ml	
Diámetro boquilla	2,5 mm	
Pulverización	850 l/min	
Densidad	50 DIN-s	

SOLDADOR ESTAÑO 100W
S100108 COD 0653
PVP: 15,54 €



- Diámetro 11,2
- 2 Recambios incluidos
- 13-18 gr/min

EAN	6925582124712	50 unid.
Voltaje	220 - 240 V / 50 - 60 Hz	
Potencia	100 W	

MINI DRILL
MG13328E COD 0344
PVP: 43,63 €



- Control de velocidad variable
- Con 1 eje flexible.
- Con 109 piezas de accesorios
- Con 1 juego de escobillas de carbón adicionales
- Maleta transporte BMC

EAN	6941640195388	4 unid.
Voltaje	220 - 240 V / 50 - 60 Hz	
Potencia	130 W	
Velocidad	10.000 - 35.000 rpm	
Tamaño de pinza	3,2 mm/2,3 mm	

MOTOBOMBAS

CATÁLOGO 2024

MOTOBOMBA GASOLINA

COD 0772

GWP152

PVP: 182,46 €

40mm(1.5")
Gasoline Engine
2.5HP



- Depósito combustible: 1.2 L

EAN	6941640124999	1 unid.
Diámetro de succión y descarga	40 mm, 1,5"	
Flujo máx	167L/min	
Aspiración máx	7 m	
Impulsión máx	18 m	
Motor de gasolina de	2.5HP	
Cubicaje	105cc	

MOTOBOMBA GASOLINA

COD 0042

GWP202

PVP: 259,21 €

50mm(2")
Gasoline Engine
7.0HP



- Depósito combustible: 3.6 L

EAN	6928073606872	1 unid.
Motor	7,0 HP - 4 tiempos	
Cubicaje	208 Cc	
Impulsión	28 m	
Aspiración	8 m	
Caudal: 100 l/min	550 l/min - 33.000 l/hora	
Conexión	50 mm - 2"	

MOTOBOMBA GASOLINA

COD 0043

GWP302

PVP: 282,51 €

80mm(3")
Gasoline Engine
7.0HP



- Depósito combustible: 3.6 L

EAN	6925582100402	1 unid.
Motor	7,0 HP - 4 tiempos	
Cubicaje	208 Cc	
Impulsión	32 m	
Aspiración	8 m	
Caudal: 100 l/min	1.000 l/min - 60.000 l/hora	
Conexión	80 mm - 3"	

MOTOBOMBA GASOLINA

COD 0044

GWP402

PVP: 521,07 €

100mm(4")
Gasoline Engine
9.0HP



- Depósito combustible: 6 L

EAN	6925582113280	1 unid.
Motor	9,0 HP - 4 tiempos	
Cubicaje	270 Cc	
Impulsión	30 m	
Aspiración	8 m	
Caudal: 100 l/min	1.500 l/min - 90.000 l/hora	
Conexión	100 mm - 4"	

BOMBA SUMERGIBLE DE AGUAS NEGRAS

COD 0209

SPD7508

PVP: 86,92 €

750W(1.0HP)
220-240V-50Hz



- Caja de cartón INGCO 100% Copper Wire Motor

EAN	6941640169266	2 unid.
Voltaje	220 - 240 / V 50 Hz	
Energía de entrada	750W (1.0 HP)	
Máx. Cabeza	8 m	
Tasa máx. caudal:	216 l/min	
Máx. Profundidad	7 M	
Diámetro del tubo	1" con el cable 9 m	

BOMBA SUMERGIBLE DE AGUAS NEGRAS

COD 0550

SPD10001

PVP: 134,31 €

1000W(1.4HP)
220-240V-50Hz



- Caja de cartón INGCO 100% Copper Wire Motor

EAN	6925582143461	2 unid.
Voltaje	220 - 240 V/50 Hz	
Potencia	1000W (1,5HP)	
Máx. Cabeza	9 m	
Tasa máx. caudal:	333 l/min	
Máx. Profundidad	7 M	
Diámetro del tubo	2" con el cable 9 m	

LIMPIADORA ALTA PRESIÓN 1400W COD 0444

HPWR14008 PVP: 114,75 €

1400W
130Bar
5.5L/min
Carbon
Brush Motor



- Acc: lanza y manguera 5 m
- Arranque y parada automático

EAN	6925582123845	1 unid.
Voltaje	220 - 240 V / 50 - 60 Hz	
Potencia	1.400 W	
Presión max	130 Bar	
Caudal	5,5 l/min	
Temperatura máxima	40°	
Conexión	50 mm - 2"	

LIMPIADORA ALTA PRESIÓN 1800W COD 0443

HPWR18008 PVP: 169,30 €

1800W
150Bar
6L/min
Carbon
Brush Motor



- Acc: lanza y manguera 5 m
- Arranque y parada automático
- Depósito detergente

EAN	6925582123852	1 unid.
Voltaje	220 - 240 V / 50 - 60 Hz	
Potencia	1.800 W	
Presión max	150 Bar	
Caudal	6 l/min	
Temperatura máxima	40°	
Conexión	50 mm - 2"	

MANGUERA 5 M HIDROLIMPIADORA COD 0372

AHPH5028 PVP: 13,60 €



Quick
connector

EAN 6925582126273 1 unid.

LANZA HIDROLIMPIADORA COD 0373

AMSG028 PVP: 22,37 €



Quick
connector

EAN 6925582126280 1 unid.

LANZA ARTICULADA HIDROLIMPIADORA COD 0555

AMAN4501 PVP: 7,60 €



590mm

- Medida 590 mm

EAN 6925582149531 1 unid.

CEPILLO HIDROLIMPIADORA COD 0552

AMHB2791 PVP: 18,30 €

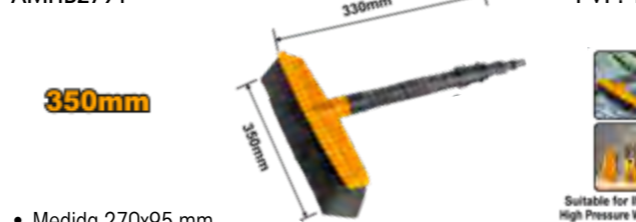

350mm

- Medida 270x95 mm

EAN 6925582149548 1 unid.

CEPILLO REDONDO HIDROLIMPIADORA COD 0553

AMPB251 PVP: 18,52 €

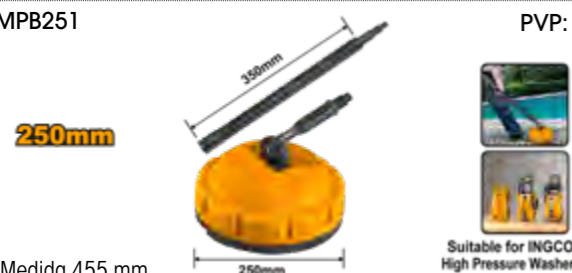

250mm

- Medida 455 mm

EAN 6925582149555 1 unid.

CEPILLO LLANTAS VEHICULO HIDROLIMPIADORA COD 0554

AMWB1781 PVP: 7,90 €



390mm

- Medida 390 mm

EAN 6925582149562 1 unid.

CONSUMIBLES

CATÁLOGO 2024

JUEGO BROCAS 5 PCS

AKDB3055

COD 0281

PVP: 2,90 €

JUEGO BROCAS PRO 5 PCS

AKD3051

COD 0282

PVP: 6,76 €

JUEGO BROCAS 5 PCS

AKDB5055

COD 0287

PVP: 2,22 €

JUEGO BROCAS PLANAS 12 PCS

AKDL1201

COD 1041

PVP: 23,14 €



- Obra general
- 4 x 75 mm / 5 x 85 mm / 6 x 100 mm / 8 x 120 mm / 10 x 120 mm
- 5 Pcs para hormigón
- Doble blíster

EAN 6928073713365 40 unid.



- Obra general
- 4 x 75 mm / 5 x 85 mm / 6 x 100mm / 8 x 120 mm / 10 x 120 mm
- 5 Pcs para hormigón
- Caja de plástico

EAN 6928073677728 24 unid.



- Para madera
- 3 x 61mm / 4x75 mm / 5 x 86 mm / 6 x 93 mm / 8 x 117 mm
- 5 Pcs para madera
- Doble blíster

EAN 6925582102574 40 unid.



- Para madera
- 6/8/10/12/14/16/18/20/25/28/30/32
- Vástago hexagonal 1/4
- Largo 152mm
- Caja plástico

EAN 6925582147339 40 unid.



JUEGO BROCAS 6 PCS

AKDB1065

COD 0283

PVP: 2,51 €

JUEGO BROCAS PRO 6 PCS

AKD1055

COD 0284

PVP: 3,80 €

JUEGO BROCAS PRO 25 PCS

AKD1251

COD 0288

PVP: 82,26 €

JUEGO BROCAS 16 PCS + PUNTAS

AKSDB9165

COD 0289

PVP: 4,82 €



- HSS
- 2 x 49 mm / 3 x 61 mm / 4 x 75 mm / 5 x 86 mm / 6 x 93 mm / 8 x 117 mm
- 6 Pcs para metal
- Doble blíster

EAN 6925582102581 40 unid.



- HSS
- 2 / 3 / 4 / 5 / 6 / 8 mm
- 6 Pcs para metal
- Caja de plástico

EAN 6928073680315 12 unid.



- 25 Pcs brocas HSS metal
- Brocas 135°
- Acero de alta velocidad y calidad m2
- Tamaño broca: 1-13 mm / 0,5 mm
- Caja de plástico

EAN 6925582100198 10 unid.



- 6 Pcs para metal 2 / 3 / 3.5 / 4 / 5 / 6 mm
- 4 Pcs para hormigón 4 / 5 / 6 / 8 mm
- 6 Pcs puntas de 25 mm SL4.5,SL5.5,PH1,PH2,PZ1,PZ2
- Doble blíster

EAN 6928073713372 20 unid.

JUEGO BROCAS 12 PCS

AKDB1125

COD 0285

PVP: 4,69 €

JUEGO BROCAS PRO 19 PCS

AKDB1195

COD 0286

PVP: 12,60 €

JUEGO BROCAS PRO 16 PCS

AKDL11601

COD 0290

PVP: 9,90 €

JUEGO DE BROCAS PRO SDS PLUS 5 PCS

AKD2052

COD 0291

PVP: 7,06 €

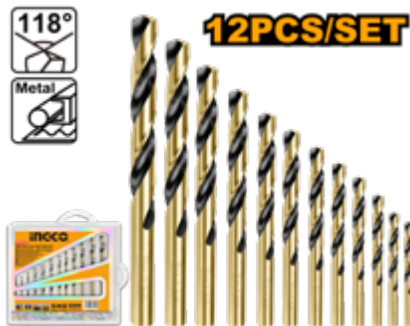

- SS
- 2 / 2.5 / 3 / 3.5 / 4 / 4.5 / 5 / 5.5 / 6 / 6.5 / 7 / 8 mm
- 12 Pcs para metal
- Doble blíster

EAN 6928073714515 20 unid.



- HSS
- 1 / 1.5 / 2 / 2.5 / 3 / 3.5 / 4 / 4.5 / 5 / 5.5 / 6 / 6.5 / 7 / 7.5 / 8 / 8.5 / 9 / 9.5 / 10 mm
- 19 Pcs para metal
- Caja de plástico

EAN 6928073713358 10 unid.



- 6 Pcs para metal 2 / 3 / 4 / 5 / 6 / 8 mm
- 5 Pcs para hormigón 4 / 5 / 6 / 8 / 10 mm
- 5 Pcs para madera 4 / 5 / 6 / 8 / 10 mm
- Caja de plástico

EAN 6925582147353 6 unid.



- Brocas para hormigón
- Medida : 6 x 110 mm / 8 x 110 mm / 8 x 160 mm / 10 x 160 mm / 12 x 160mm
- Caja de plástico

EAN 6928073673263 5 unid.

VARILLA MEZCLADORA



- Diámetro: 120 / 160 mm
- Largo: 600 mm
- Métrica 14

EAN	REF	COD	5 unid.	PVP
6928073670132	MP1120	0446		11,68 €
6928073667002	MP1160	0317		15,88 €

PORTABROCAS 13MM

KC1301

COD 0216

PVP: 5,14 €



- Tamaño conexión: 1/2" 20UNF
- Portabrocas 1,5 - 13mm
- Llave mandril incluida

EAN	6928073660379	25 unid.
-----	---------------	----------

PORTABROCAS AUTOMÁTICO

KCL1301

COD 0269

PVP: 7,32 €



- Tamaño conexión: 1/2" 20UNF
- Portabrocas 1,5 - 13mm

EAN	6928073668603	25 unid.
-----	---------------	----------

PORTABROCAS 10 MM

KC1001

COD 0215

PVP: 4,72 €



- Tamaño conexión: 3/8" 24UNF
- Portabrocas 0,8 - 10mm
- Llave mandril incluida

EAN	6928073660362	25 unid.
-----	---------------	----------

PORTABROCAS 13MM CON ADAPTADOR SDS PLUS

KC1301.1

COD 0217

PVP: 6,04 €



- Tamaño conexión: 1/2" 20UNF
- Portabrocas 1,5 - 13mm
- Llave mandril y adaptador sds plus incluidos

EAN	6928073666418	25 unid.
-----	---------------	----------

LLAVE MANDRIL

CK1301

COD 0218

PVP: 1,32 €



- Llave para 13 mm
- Longitud llave de sujeción: 80 mm

EAN	6928073668610	25 unid.
-----	---------------	----------

PUNTERO SDS PLUS

DBC0112501

COD 0292

PVP: 2,52 €



- 14 x 250 mm
- Adecuado para RGH9018, RH150028, RGH9028

EAN	6925582108262	50 unid.
-----	---------------	----------

CINCEL SDS PLUS

DBC0122501

COD 0293

PVP: 2,52 €



- 14 x 250 x 20 mm
- Adecuado para RGH9018, RH150028, RGH9028

EAN	6925582108279	50 unid.
-----	---------------	----------

PUNTERO SDS MAX

DBC0214001

COD 0374

PVP: 6,68 €



- 18 x 400 mm
- Adecuado para RH17001, RH16008, PDB15006

EAN	6928073661840	25 unid.
-----	---------------	----------

CINCEL SDS MAX

DBC0224001

COD 0375

PVP: 6,86 €



- 18 x 400 x 25 mm
- Adecuado para RH17001, RH16008, PDB15006

EAN	6928073661871	25 unid.
-----	---------------	----------

PUNTERO HEXAGONAL 30MM

DBC0314101

COD 0294

PVP: 23,29 €



- 30 x 410 mm
- Adecuado para PDB17008

EAN	6928073666319	10 unid.
-----	---------------	----------

CINCEL HEXAGONAL 30MM

DBC0324102

COD 0295

PVP: 23,29 €



- 30 x 410 x 40 mm
- Adecuado para PDB17008

EAN	6928073666326	10 unid.
-----	---------------	----------

CINCEL PALA ANCHA SDS PLUS

DBC0122502

COD 0447

PVP: 3,73 €



- 14 x 250 x 40 mm
- Adecuado para RGH9018, RH150028, RGH9028

EAN	6928073667200	50 unid.
-----	---------------	----------

CINCEL PALA ANCHA SDS MAX

DBC0224002

COD 0448

PVP: 7,88 €



- 18 x 400 x 50 mm
- Adecuado para RH17001, RH16008 Y PDB15006.

EAN	6928073666241	25 unid.
-----	---------------	----------

CINCEL PALA ANCHA HEXAGONAL 30MM

DBC0324103

COD 0556

PVP: 35,16 €



- 30 x 410 x 100 mm
- Adecuado para PDB17008

EAN	6928073666333	25 unid.
-----	---------------	----------

PUNTERO HEXAGONAL 17 MM COD 0449

DBC0513501 PVP: 4,50 €



- 17 x 350mm
- Adecuado para PDB130018

EAN 6925582146578 25 unid.

CINCEL HEXAGONAL 17 MM COD 0450

DBC0523501 PVP: 4,50 €



- 17 x 350 x 22mm
- Adecuado para PDB130018

EAN 6925582146585 25 unid.

BLÍSTER 5 SIERRAS CALAR COD 0324

JBT1101B PVP: 3,35 €



- Para madera
- Longitud del diente: 74 mm
- Espacio entre dientes: 4 - 5,2 mm
- Dientes rectificadas y cónicas • Paquete de 5 Pcs

EAN 6941640160713 25 unid.

BLÍSTER 5 SIERRAS CALAR COD 0326

JBT118A PVP: 3,58 €



- Para metal
- HSS
- Paquete de 5 Pcs
- Longitud del diente: 50 mm
- Espacio entre dientes: 1,9 - 2,3 mm
- Conjunto ondulado, fresado
- Chapa de espesor medio (2,5 - 6 mm)

EAN 6941640159830 25 unid.

PUNTERO HEXAGONAL 28MM COD 1042

DBC0415301 PVP: 27,86 €



- 28 x 530mm
- Adecuado para PDB22001

EAN 6925582108385 5 unid.

CINCEL HEXAGONAL 28MM COD 1043

DBC0425302 PVP: 27,86 €

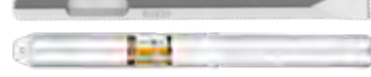

- 28 x 35 x 530mm
- Adecuado para PDB22001

EAN 6925582108392 5 unid.

BLÍSTER 5 SIERRAS CALAR COD 0325

JBT244D PVP: 2,77 €



- 6TPI
- Para madera
- Paquete de 5 Pcs
- Longitud del diente: 74 mm
- HCS, juego lateral, madera blanda, madera blanda molida (5 - 50 mm), tableros aglomerados, madera contrachapados con núcleo de madera, tableros de fibra, especialmente para cortes curvados

EAN 6928073677780 25 unid.

BLÍSTER 5 SIERRAS CALAR SURTIDAS COD 0327

AKJ0051 PVP: 3,05 €



- 2 Pcs JBT111c para madera
- 2 Pcs JBT118b para metal
- 1 Pcs JBT127d para aluminio
- Paquete de 5 Pcs

EAN 6928073677582 25 unid.

BLÍSTER 5 SIERRAS CALAR COD 0323

JBT111C PVP: 1,83 €



- Basicamente para madera
- Longitud del diente: 74 mm
- 8TPI
- HCS, paquete de 5 Pcs

EAN 6928073669099 25 unid.

BLÍSTER 2 SIERRAS SABLE COD 0329

SSB922EF PVP: 3,73 €



- Flexible
- 150 mm x 19 x 0,9 mm
- 18TPI - bi-metal - milled
- Adecuado para RS8008
- Paquete de 2 Pcs, 1/2" shank
- Corta todos los metales, incluidos los conductos no ferrosos (<100 mm), inoxidable y chapa rieles (1,5 - 4 mm)

EAN 6928073673478 25 unid.

HOJAS ARCO DE SIERRA BIMETAL COD 0451

HSBB22188 PVP: 15,60 €
PVP: 1,56 € unid.



- Medidas: 300 mm
- Bimetal: M42 + D6A
- Pack indivisible 10 unid.

EAN 6941640162007 10 unid.

BLÍSTER 2 SIERRAS SABLE COD 0328

SSB644D PVP: 1,66 €



- Para madera
- 150 x 19 x 1,25 mm
- 6TPI - HCS
- Diámetro < 100 mm
- Adecuado para RS8008
- 1/2" shank paquete de 2 Pcs
- Corte rápido para madera, materiales de composición y plástico

EAN 6928073673461 25 unid.

BLÍSTER 5 SIERRAS SABLE COD 1044

RSB1111DF PVP: 10,10 €



- Para madera
- 225 x 19 x 1,25mm
- 6TPI-BIM

EAN 6941640192585 80 unid.

JUEGO ACCESORIOS MINI DRILL COD 0654

AKMG4101 PVP: 40,52 €



EAN 6941640162175 5 unid.

BLÍSTER 5 LIJAS PARA FS3208

COD 0302

AKFS240101-1

PVP: 0,84 €



Medidas:

- 5 pcs por blister
- 3 Pcs P80 / 2 Pcs P120

EAN 6925582117738 25 unid.

BLÍSTER 5 LIJAS PARA FS35028

COD 0378

AKFS264115

PVP: 1,36 €



Medidas:

- 5 pcs por blister
- 3 Pcs P80 / 2 Pcs P120

EAN 6925582124934 25 unid.

BLÍSTER 5 LIJAS PARA CROSLI2001

COD 0560

AKRS125051

PVP: 1,69 €



- 125mm
- 5 Pcs. por blister
- 3 Pcs P80 / 2 Pcs P120

EAN 6928073666395 20 unid.

BLÍSTER 5 LIJAS PARA RS4508

COD 0303

AKRS150051

PVP: 2,06 €



- 150 mm
- 5 Pcs. por blister
- 3 Pcs P80 / 2 Pcs P120

EAN 6928073671030 20 unid.

BLÍSTER 2 LIJAS PARA PBS12001

COD 0304

BSP020801

PVP: 3,37 €



- 100 x 610 mm
- P80 / 2 pcs por blister

EAN 6928073665770 10 unid.

LIJA PARA LIJADORA DE MUROS

COD 0379

AKRS225061

PVP: 5,59 €



- Adecuado para DWS6003 y DWS10501
- 225 MM
- Plato 22
- P60, P80, P120, P150, P180, P240 (6 Lijas)

EAN 6925582113471 12 unid.

BLISTER 20 LIJAS MOUSE

COD 0773

AKTS080201

PVP: 3,24 €



80mm(3-9/64")
10PCS/SET
Effectivex1.2 Life Spanx1.2



- Delta de 80 mm
- P40x4 P60x4 P80x6 P120x6
- 10 piezas/juego
- Compatible CMLI2001 y MF3008
- 20% más efectivo
- Envasado en blister

EAN 6941640163745 12 unid.

BLISTER 20 LIJAS MOUSE

COD 0774

AKTS080202

PVP: 3,96 €



80mm(3-9/64")
20PCS/SET
Effectivex2 Life Spanx2.4



- Delta de 80 mm
- P40x4 P60x4 P80x6 P120x6
- 20 piezas/juego
- Compatible CMLI2001 y MF3008
- 20% más efectivo
- Envasado en blister

EAN 6941640166302 1 unid.

DISCO CORTE METAL-INOX 115MM

COD 0523

MCD11011525

PVP: 11,65 €
PVP: 0,46 € unid.



- Diámetro: 115 mm
- Diámetro int: 22,2 mm
- Espesor: 1 mm
- Velocidad: 13.300 Rpm
- Caja metálica: 25 unidades

EAN 6976051786856 20 unid.

DISCO CORTE METAL-INOX 115MM

COD 0524

MCD10115100

PVP: 41,02 €
PVP 0,41 € unid.



- Diámetro: 115 mm
- Diámetro int: 22,2 mm
- Espesor: 1 mm
- Velocidad: 13.300 Rpm
- Caja metálica: 100 unidades

EAN 6941640180872 4 unid.

DISCO CORTE METAL-INOX 125MM

COD 0631

MCD101251

PVP: 16,50 €
PVP: 0,66 € unid.



- Diámetro: 125mm
- Diámetro int: 22,2mm
- Espesor: 1mm
- Velocidad: 12.200 rpm
- Caja metálica 25 unidades

EAN 6941640184375 400 unid.

DISCO CORTE METAL-INOX 230MM

COD 0632

MCD302303

PVP: 1,98 €



- Diámetro: 230 mm
- Diámetro int: 22,2 mm
- Espesor: 1,9 mm
- Velocidad: 6.650 rpm

EAN 6925582106206 50 unid.

UNIVERSAL SEGMENTADO

DMD01



- Corte seco y húmedo
- Blíster

EAN	REF	COD	1 unid.	PVP
6925582106442	DMD01-1151	0197	Diámetro 115	5,24 €
6928073665220	DMD01-1252	0198	Diámetro 125	5,34 €
6941640174703	DMD01-2301	0200	Diámetro 230	16,54 €

UNIVERSAL SEMI-SEGMENTADO

DMD03



- Corte seco y húmedo
- Blíster

EAN	REF	COD	1 unid.	PVP
6925582108781	DMD03-1151	0205	Diámetro 115	5,60 €
6925582104028	DMD03-1252	0206	Diámetro 125	11,96 €
6925582108798	DMD03-2301	0208	Diámetro 230	18,32 €

JUEGO CORONAS BIMETAL MALETÍN DE ALUMINIO COD 0219

AKH0121

PVP: 85,32 €



- Sierra de perforación: 12 piezas
- Tamaño: 20 mm / 22 mm / 25 mm / 29 mm / 32 mm / 35 mm / 38 mm / 44 mm / 48 mm / 50 mm
- Incluye 2 mandriles de alta calidad
- Maletín de aluminio

EAN	REF	COD	10 unid.	PVP
6928073663257				

UNIVERSAL AZULEJOS

DMD02



- Corte húmedo
- Blíster

EAN	REF	COD	1 unid.	PVP
6925582106466	DMD02-1151	0201	Diámetro 115	4,74 €
6925582108453	DMD02-1252	0202	Diámetro 125	5,34 €
6925582108460	DMD02-2302	0204	Diámetro 230	14,52 €

JUEGO DE CORONAS

COD 0220

AKHS702

PVP: 6,22 €



- 7 piezas
- Diámetro del agujero VIO: 26 mm / 32 mm / 38 mm / 45 mm / 50 mm / 56 mm / 63 mm
- Altura: 50 mm (2")
- Embalado con tarjeta de percha

EAN	REF	COD	10 unid.	PVP
6928073665442				

CUCHILLA CORTADOR CERÁMICA

COD 0348

HTC04600B

PVP: 3,10 €



- Cortador de azulejos
- Material: carburo de tungsteno • Adaptada para HTC04600

EAN	REF	COD	50 unid.	PVP
6925582119459				

Tamaño cuchilla 16 x 6 x 3 mm

CUCHILLA CORTADOR CERÁMICA

COD 0350

HTC04800B

PVP: 8,22 €



- Hoja de corte para azulejos
- Rodamiento de bolas
- Material: carbón tungsteno
- Adaptada para HTC04800AG



EAN	REF	COD	1 unid.	PVP
6925582119633				

Tamaño cuchilla 22 x 10,5 x 2 mm

HUSILLO HEXAGONAL PARA CORONA 14-30MM COD 0561

HSA01

PVP: 3,91 €



- Incluye broca piloto HSS
- Vástago hexagonal 3/8"

EAN	REF	COD	10 unid.	PVP
6928073664698				

HUSILLO HEXAGONAL PARA CORONA 32-210MM COD 0562

HSA02

PVP: 8,69 €



- Incluye broca piloto HSS
- Vástago hexagonal 7/16"

EAN	REF	COD	12 unid.	PVP
6928073664704				

CORONA BIMETAL



- Dientes endurecidos HSS

EAN	REF	COD	10 unid.	PVP
6928073667880	HSB10161	0563	Corte 16 mm	2,06 €
6928073664490	HSB10191	0564	Corte 19 mm	3,53 €
6928073667927	HSB10221	0565	Corte 22 mm	3,89 €
6928073667934	HSB10251	0566	Corte 25 mm	4,21 €
6928073667972	HSB10321	0567	Corte 32 mm	5,37 €
6928073668016	HSB10381	0568	Corte 38 mm	6,12 €

CEPILLO ABRASIVO COPA NYLON



- Vástago 1/4
- Velocidad 4500 rpm
- Filamento 1,2 mm

EAN	REF	COD	120 unid.	PVP
6925582152500	WB30505	0657	50 mm	2,59 €
6925582152517	WB30755	0658	75 mm	4,09 €

CORONA BIMETAL



- Dientes endurecidos HSS

EAN	REF	COD	10 unid.	PVP
6928073664537	HSB10461	0569	Corte 46 mm	7,45 €
6928073668061	HSB10511	0570	Corte 51 mm	8,17 €
6928073668115	HSB10641	0571	Corte 64 mm	10,13 €
6928073668139	HSB10681	0634	Corte 68 mm	11,75 €
6928073668160	HSB10761	0572	Corte 76 mm	12,27 €

CEPILLO ABRASIVO PLANO NYLON



- Vástago 1/4
- Velocidad 4500 rpm
- Filamento 1,2 mm

EAN	REF	COD	12 unid.	PVP
6925582152524	WB40755	0659	75 mm	3,25 €
6925582152531	WB41005	0660	100 mm	4,83 €

CEPILLO COPA ACERO LATONADO



- Vástago 1/4
- Velocidad 4500 rpm
- Filamento 0,3 mm

EAN	REF	COD		PVP
6928073661291	WB30501	0661	144 u./caja	50 mm 1,54 €
6928073661307	WB30751	0662	120 u./caja	75 mm 2,02 €

CEPILLO BROCHA ACERO LATONADO

WB70241

COD 0666

PVP: 1,48 €



25mm(1")



- Vástago 1/4
- Velocidad 4500 rpm
- Alambre 0,3 mm
- Longitud alambre 25 mm
- Diámetro 25 mm

EAN	6928073666876		240 unid.
-----	---------------	--	-----------

CEPILLO COPA ACERO TRENZADO

WB21005

COD 0668

PVP: 6,24 €

LONG LIFE x 3
Vibration Control **100mm(4")**



- Rosca M 14
- Velocidad 12.500 rpm
- Alambre 0,5 mm
- Longitud alambre 30 mm
- Diámetro 100 mm

EAN	6941640109613		30 unid.
-----	---------------	--	----------

CEPILLO PLANO ACERO LATONADO



- Vástago 1/4
- Velocidad 4500 rpm
- Filamento 0,3 mm

EAN	REF	COD		PVP
6928073669112	WB40501	0663	240 u./caja	50 mm 1,18 €
6928073666340	WB40751	0664	144 u./caja	75 mm 1,70 €
6928073661321	WB41001	0665	60 u./caja	100 mm 2,20 €

CEPILLO COPA ACERO LATONADO

WB11005

COD 0667

PVP: 5,67 €

LONG LIFE x 3
Vibration Control **100mm(4")**



- Rosca M 14
- Velocidad 8500 rpm
- Alambre 0,3 mm
- Longitud alambre 30 mm
- Diámetro 100 mm

EAN	6941640109552		30 unid.
-----	---------------	--	----------

BROCA CAZOLETA 35MM PARA MADERA

ADCS3501

COD 0775

PVP: 5,40 €



35mm



EAN	69280073661420		30 unid.
-----	----------------	--	----------

DISCO ABRASIVO LAMINAS DE ZIRCONIO



- Diámetro 115mm
- Grueso 22 mm

EAN	REF	COD		200 unid.	PVP
6941640160911	FDZ1151	0669		115P40	2,00 €
6941640155801	FDZ1152	0670		115P60	1,92 €
6941640160928	FDZ1153	0671		115 P80	1,92 €

SET DISCOS LIJA ZIRCONIO

AKRS125101

COD 0675

PVP: 4,08 €



- Diámetro 125mm
- 10 unidades
- 2 x P40, 2 x P60, 3 x P80, 2 x P120

EAN	6941640153173		40 unid.
-----	---------------	--	----------

CADENA MOTOSIERRA



EAN	REF	COD		50 unid.	PVP
6941640141491	AGSC51001	0679		10"	11,99 €
6941640131263	AGSC51601	0680		16"	17,16 €
6941640133458	AGSC51801	0681		18"	18,39 €

HILO DESBROZADORA

ALS25405

COD 0704

PVP: 12,96 €

- Diámetro hilo 2,5 mm
- Longitud hilo 4 m

EAN	6941640145437		25 unid.
-----	---------------	--	----------

DISCO ABRASIVO LAMINAS DE ZIRCONIO



- Diámetro 125mm
- Grueso 22 mm

EAN	REF	COD		200 unid.	PVP
6941640166043	FDZ1251	0672		125 P40	2,36 €
6941640163509	FDZ1252	0673		125 P60	2,21 €
6941640168627	FDZ1253	0674		125 P80	2,21 €

SET DISCOS LIJA ZIRCONIO



- Diámetro 150 mm
- 10 unidades
- 2 x P800, 2 x P1000, 2 x P1200, 2 x P1500, 2 x P2000 (Cod. 676)
- 2 x P80, 1 x P120, 2 x P180, 2 x P240, 2 x P320, 1 x P400 (Cod. 677)
- 2 x P40, 2 x P60, 4 x P180, 2 x P120 (Cod. 678)

EAN	REF	COD		40 unid.	PVP
6941640165961	AKRS150101	0676		150 mm	5,51 €
6941640163394	AKRS150102	0677		150 mm	5,51 €
6941640150608	AKRS150103	0678		150 mm	5,51 €

ESPADA MOTOSIERRA

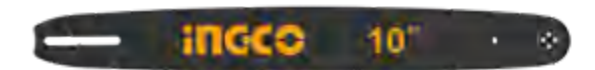

EAN	REF	COD		25 unid.	PVP
6941640146618	AGSB51001	0682		10"	10,93 €
6941640136381	AGSB51601	0683		16"	16,64 €
6941640131089	AGSB51801	0684		18"	18,01 €

CUCHILLA DESBROZADORA

ABCB05

COD 0705

PVP: 8,36 €

- 3 Dientes
- Diámetro 255 mm

EAN	6941640138576		50 unid.
-----	---------------	--	----------



JUEGO DE FRESAS



- 12 unidades
- Tungsteno de alta calidad
- Caja madera

EAN	COD	Ø eje	12PCS/SET	PVP
6928073667460	0376	AKRT1201	6mm	27,10 €
6928073670798	0377	AKRT1211	8mm	27,10 €
6928073667507	1045	AKRT1221	12mm	27,10 €

BLISTER CUCHILLA CEPILLO

EPB820121 PVP: 4,36 €



- Tamaño: 82 x 5,5 x 1,2 mm
- Material: HSS
- Incluye: 2 Pcs
- Doble blíster

EAN	6928083661352	1 unid.
-----	---------------	---------

COLA TERMOFUSIBLE

AKTGS3011 PVP: 15,58 €



- 1 KG Cola
- Largo: 300mm
- Diámetro: 11,2mm

EAN	6928073714447	1 unid.
-----	---------------	---------

JUEGO 15 ACCESORIOS MULTIFUNCIONES COD 0453

AKTMT1502 PVP: 14,76 €



- 15 Accesorios
- 1 Base lijadora delta 80 mm
- 10 hojas delta 80 mm
- 1 Hoja de sierra de inmersión bi-metal 34 mm
- 1 Hoja de sierra de inmersión crv 34 mm
- 1 Hoja de sierra de segmento 87 mm
- 1 Cuchilla, rasqueta 50 mm

EAN	6925582132229	10 unid.
-----	---------------	----------

COLA TERMOFUSIBLE

AKTGS2061 PVP: 2,77 €



- Set 6 unidades.
- Largo: 20 cm.
- Diámetro: 11,2 mm.

EAN	6925582100761	10 unid.
-----	---------------	----------

GRAPA 530/10

STS0110 PVP: 1,01 €



- Set 1000 Pcs
- 530/10
- Medida exterior 11,30 mm
- Medida interior 10 mm
- Grueso 0,7 mm

EAN	6925582101669	1 unid.
-----	---------------	---------

CLAVO BRAD



- Set 5000 Pcs
- Ga 18, 1,25x1mm

EAN	COD	Largo	5000PCS	PVP
6928073670729	0574	ANA18251	25mm	4,68 €
6928073712429	0575	ANA18301	30mm	5,34 €
6928073667439	0576	ANA18351	35mm	6,40 €
6928073670736	0577	ANA18401	40mm	7,22 €
6928073670743	0578	ANA18501	50mm	8,92 €

AGUJA PIN CLAVADORA 25MM

ANA06825 PVP: 6,64 €



- Set 10000 Pcs
- Ga 23
- Diámetro 0,64mm

EAN	6942141804755	36 unid.
-----	---------------	----------

PILA ALCALINA LR03 AAA (BL4)

HAB3A01 PVP: 1,36 €



- Blíster 4 unidades
- Expositor 75 blisters 300 unidades
- Capacidad 1300 mAh

EAN	6925582142037	1 unid.
-----	---------------	---------

GRAPA



- Set 2500 Pcs
- Ga 18, 1,25x1mm
- Ancho grapa 5,7mm

EAN	COD	Largo	2500PCS	PVP
6928073667446	0579	AST18251	25mm	4,96 €
6928073670699	0580	AST18351	35mm	6,94 €
6928073667453	0581	AST18401	40mm	7,88 €

PILA ALCALINA LR6 AA (BL4)

HAB2A01 PVP: 1,64 €



- Blíster 4 unidades
- Expositor 32 blisters 128 unidades
- Capacidad 2900 mAh

EAN	6925582139716	1 unid.
-----	---------------	---------

GRAPA



- Set 2500 Pcs
- Ga 18, 1,25x1mm
- Ancho grapa 5,7mm

EAN	COD	Largo	2500PCS	PVP
6928073667446	0579	AST18251	25mm	4,96 €
6928073670699	0580	AST18351	35mm	6,94 €
6928073667453	0581	AST18401	40mm	7,88 €

PILA ALCALINA LR03 AAA (BL4)

HAB3A01 PVP: 1,36 €



- Blíster 4 unidades
- Expositor 75 blisters 300 unidades
- Capacidad 1300 mAh

EAN	6925582142037	1 unid.
-----	---------------	---------

HTCS273281

CHEST PART:

- With 7 Pcs drawers
- Overall size: 65x465x812mm
- Overall with casters size: 765x465x976mm
- Casters size: 5" x 2"
- Thickness of Cabinet: 0.8-1.0mm
- Thickness of drawer: 0.7mm
- With 5 Pcs 536x410x74.5mm drawer
- With 2 Pcs 536x410x153.5mm drawer
- 5 Pcs iron hooks(for hanger tools)
- Packed in EVA foam + carton box + Pallet

TOOLS PART:

- 1 Pcs Ratchet wrench: 1/4"
- 13 Pcs 1/4" socket 4-4.5-5-5.5-6-7-8-9-10-11-12-13-14
- 24 Pcs 1/4" x 32(L) bits Socket: Hex: 3-4-5-6-7-8-10mm Star: T8-T10-T15-T20-T25-T27-T30-T40 SL: 4-5-5-7mm, PH1, PH2, PH3, PZ1, PZ2, PZ3.
- 8 Pcs 1/4" DR 50mm(L) Deep socket: 6-7-8-9-10-11-12-13mm
- 6 Pcs 1/4" star socket: E4-E5-E6-E7-E8-E10
- 2 Pcs Extension bar: 1/4"Dr. x 50mm, 1/4"Dr. x 100mm
- 1 Pcs Spinner handle: 1/4"x150mm
- 1 Pcs Extension flexible bar : 1/4" x 150mm
- 1 Pcs 1/4" Universal joint
- 1 Pcs Sliding "T" Bar: 1/4"x 114mm
- 1 Pcs 1/4" three way adaptor: 3/8"(F)x1/4"(M)
- 1 Pcs bit holder: 1/4"x6.35mm
- 40 Pcs 6.35x25mm(L) bits: T5-T6-T7-T8-T9-T10-T15-T20-T25-T30-PH1-PH2-PH2-PH3-PH4-PZ1-PZ2-PZ2-PZ3-PZ4-SL3-SL3-SL4-SL4-SL5-SL5.5-SL6-SL6.5-SL7-SL7-H2-H3-H3-H4-H4-H5-H5-H6-H7-H7
- 1 Pcs magnetic shank: 6.35mmx100mm
- 1 Pcs Ratchet wrench: 1/2"
- 1 Pcs 1/2" Universal joint
- 19 Pcs 1/2" DR Socket: 8-10-11-12-13-14-15-16-17-18-19-20-21-22-23-24-27-30-32mm
- 4 Pcs 1/2" DR 77mm(L) Deep socket: 14-15-17-19mm
- 8 Pcs 1/2" Star Socket: E10 12 14 16 18 20 22 24
- 2 Pcs Spark plug socket: 1/2"Dr. 16mm -21mm
- 1 Pcs 1/2"x250mm Sliding T bar
- 2 Pcs Extension bar: 1/2"Dr. x 100mm, 1/2"Dr. x 250mm
- 3 Pcs 1/2"x58mm(L) bits socket: T55, T60, T70
- 1 Pcs 1/2" three way adaptor: 3/8"(F)x1/2"(M)
- 32 Pcs 8x30mm(L) bits: PH3, PH4, PZ3, PZ4, H7, H8, H10, H12, H14, SL, SL6, SL6.5, SL8, T20, T25, T27, T30, T35, T40, T45, T50, T55, T27H, T30H, T35H, T40H, T45H, T50H, M5, M6, M8, M10
- 1 Pcs bit holder: 1/2"x8mm
- 13 Pcs 3/8" hexagonal socket: 10, 11, 12, 13, 14, 15, 16, 17, 18, 19, 21, 22, 24mm
- 9 Pcs 3/8" deep hexagonal socket: 10, 11, 12, 13, 14, 15, 16, 17, 19mm
- 7 Pcs 3/8" star socket: E10, E11, E12, E14, E16, E18, E20
- 1 Pcs ratchet wrench: 3/8"
- 2 Pcs 3/8" extension bar: 75mm(3"), 150mm(6")
- 1 Pcs Dr. Universal joint: 3/8"
- 1 Pcs 3/8" three way adaptor: 3/8"(F)x3/8"(M)
- 14 Pcs screwdriver: SL3x75, SL4x100, SL5.5x100, SL6.5x38, SL6.5x125, SL6.5x150, SL8x200, PH0x75, PH1x75, PH1x100, PH2x38, PH2x125, PH2x150, PH3x200
- 8 Pcs T-handle hexwrench: 2x100mm, 2.5x100mm, 3x100mm, 4x150mm, 5x150mm, 6x150mm, 8x200mm, 10x200mm
- 8 Pcs T-handle Torx wrench: T10x100mm, T15x100mm, T20x100mm, T25x150mm, T30x150mm, T40x150mm, T45x200mm, T50x200mm
- 17 Pcs Combination spanner: 6, 7, 8, 9, 10, 11, 12, 13, 14, 15, 16, 17, 18, 19, 21, 22, 24
- 5 Pcs Flare nut Spanner: 8x10, 10x12, 11x13, 12x14, 17x19
- 5 Pcs Double flexible socket wrench: 8x10, 10x12, 12x14, 14x17, 17x19
- 12 Pcs Offset ring spanner: 6x7, 8x9, 10x11, 12x13, 14x15, 16x17, 18x19, 20x22, 21x23, 24x27, 25x28, 30x32.
- 9 Pcs Hex Key Wrench: 1.5, 2, 2.5, 3, 4, 5, 6, 8, 10
- 9 Pcs Trox Key Wrench: T10, T15, T20, T2, T27, T30, T40, T45, T50
- 1 Pcs 10" Curved jaw lock wrench
- 1 Pcs 40mm Rubber and plastic hammer
- 1 Pcs 10" Water pump pliers
- 1 Pcs 8" high leverage long nose pliers
- 1 Pcs 8" high leverage bent nose pliers
- 1 Pcs 8" high leverage combination pliers
- 1 Pcs 7" high leverage diagonal cutting pliers
- 4 Pcs circlip pliers
- 1 Pcs 300g Machinist Hammer
- 1 Pcs 10" Adjustable wrench 1 Pcs Hacksaw frame
- 3 Pcs cold chisel: 10x142mm 13x152mm 16x172mm
- 6 Pcs pin punch: 1.5x152mm 3x152mm 4x152mm 5x152 6x152mm 8x152mm
- 1 Pcs taper punch: 2x140mm(3/32"x5-1/2")
- 2 Pcs centre punch: 6x102mm(1/14"x4") 8x115mm(5/16"x4-1/2")
- 5 Pcs steel file set:
 - Flat steel file 1 Pcs
 - Half round steel file 1 Pcs
 - Round steel file 1 Pcs
 - Triangle steel file 1 Pcs
 - Square steel file 1 Pcs



HERRAMIENTA MANUAL

CATÁLOGO 2024

MALETA HERRAMIENTAS 20 PCS 1/4"

COD 0808

HKTS14201

PVP: 20,70 €



- 20 Pcs 1/4
- Material: CR-V (50BV30)
- Maleta BMC
- 1 pcs 1/4"DR. Llave carraca,45T
- 13pcs 1/4"DR. Vasos: 4, 4.5, 5, 5.5, 6, 7, 8, 9, 10, 11, 12, 13, 14mm
- 1 pcs 1/4"DR. Extension 2"(50mm)
- 1 pcs 1/4"DR. Destornillador 1/4
- 4pcs 1/4"DR. Vasos extralargos:8,10,12,13mm
- 1 pcs 1/4" DR. Llave carraca,45T

EAN 6941640175458 2 unid.

MALETA HERRAMIENTAS 46 PCS 1/4"

COD 0054

HKTS14462

PVP: 32,28 €



- Juego de 45 piezas
- Llaves de vaso de 1/4, puntas, vasos, alargaderas, rótula, mango corredizo, etc.
- Maleta BMC

EAN 6942141803086 6 unid.

MALETA HERRAMIENTAS 44 PCS 1/4" - 1/2"

COD 0056

HKTS42441

PVP: 107,96 €



- Juego de llaves de vaso de 1/2 - 1/4
- Uso intensivo, vasos hasta 3 mm, alargaderas, rótulas, mango corredizo, etc.
- Maleta BMC

EAN 6925582115741 4 unid.

MALETA HERRAMIENTAS 82 PCS 1/4" - 1/2"

COD 1047

HKTS42802

PVP: 98,67 €



- Juego de llaves de vaso de 1/4" - 1/2"
- Uso intensivo vasos hasta 32mm
- Llaves combinadas: 8-10-11-12-13-14-17-19-22
- Alargaderas, puntas, mango corredizo, etc.
- Maleta BMC

EAN 6942141807688 12 unid.

MALETA HERRAMIENTAS 20 PCS 1/2"

COD 0809

HKTS12201

PVP: 44,94 €



- 20 Pcs 1/2
- Material: CR-V(50BV30)
- Maleta BMC
- 1 pcs 1/2"DR. Llave carraca,45T
- 12pcs 1/2"DR. Vasos: 10,11,12,13,14,15,16,17,18,19,22,24mm
- 1 pcs 1/2"DR. Vaso bujía: 16mm
- 1 pcs 1/2"DR. Adaptador universal
- 1 pcs 1/2"DR. Extensión: 10" (250mm)
- 1 pcs 1/2"DR. Articulación
- 3pcs 1/2"DR. Vasos extra-largos: 13,17,19mm

EAN 6941640185921 1 unid.

MALETA HERRAMIENTAS 25 PCS 1/2"

COD 0055

HKTS12251

PVP: 71,12 €



- Juego de llaves de vaso de 1/2
- Uso intensivo, vasos hasta 32 mm, alargadera, rótula, mango corredizo, etc.
- Maleta BMC

EAN 6928073673294 4 unid.

MALETA HERRAMIENTAS 94 PCS 1/4 - 1/2"

COD 0057

HKTS42941

PVP: 109,30 €



- Juego de llaves de vaso de 1/2 - 1/4
- Uso intensivo, vasos hasta 32 mm
- Alargaderas, puntas, mango corredizo, etc.
- Maleta BMC

EAN 6925582103243 2 unid.

MALETA DE HERRAMIENTAS 100 PCS 1/4" - 1/2"

COD 0053

HKTHP21001

PVP: 156,88 €



- Llaves combinadas, alicate universal, alicate corte diagonal, destornilladores, vasos, martillo, llaves allen, puntas.
- Maleta BMC

EAN 6925582114515 4 unid.

MALETA DE HERRAMIENTAS 142 PCS 1/4"-3/8"-1/2" COD 0058

HKTHP21421

PVP: 265,82 €



- Juego de llaves de vaso de 1/2 - 1/4 - 3/8
- Incluye: alicates, mordaza, martillo, puntas, llaves Allen, destornilladores, etc.
- Maleta BMC

EAN 6925582115666 1unid.

MALETA HERRAMIENTAS 216 PCS 1/4"-3/8"-1/2" COD 1048

HKTHP22161

PVP: 219,64 €



- Juego de llaves de vaso de 1/4" - 3/8" - 1/2"
- Uso intensivo vasos hasta 32mm
- Llaves combinadas: 8-10-11-12-13-14-15-16-17-19-22
- Alargaderas, puntas, mango corredero, etc
- Maleta BMC

EAN 6976051781318 1unid.

CAJA HERRAMIENTAS 147 PCS 1/4" - 1/2" COD 0582

HKTHP21471

PVP: 274,62 €

Caja aluminio, con carro:
Incluye:

- 1 Lima de acero semicircular 200mm
- 1 Nivel 40cm
- 1 Martillo de maquinista 300g
- 1 Sierra de arco para metales de 300 mm
- 1 Cinta métrica de acero 5M
- 1 Set 9pcs Llave allen 1.5/2/2.5/3/4/5/6/8/10
- 1 Alicata universal 180mm
- 1 Alicates de punta larga 160mm
- 1 Alicata corte diagonal de 160mm
- 1 Alicata universal de 220 mm
- 1 Llave stilson 250mm
- 1 Llave ajustable de 200mm
- 1 Mordaza de bloqueo curva de 250mm
- 1 Tijeras de 220mm
- 9 Piezas Llave combinadas 6/8/10/12/14/15/17/19/22
- 4 Destornillador punta plana SL8 * 150 / SL6 * 125 / SL5 * 100 / SL6.5 * 38
- 3 Destornillador Phillips PH2 * 150 / PH1 * 100 / PH2 * 38
- 1 Pieza de vástago magnético de 1/4"
- 2 Destornillador aislado electricista SL5 * 125 / PH2 * 100
- 1 Detector de corriente
- 1 Llave carraca de 1/2", 45 dientes
- 1 Llave carraca de 1/4", 45 dientes
- 1 Mango giratorio de 1/4" * 150 mm
- 1 barra de extensión flexible de 1/4" * 150 mm



- 1 Adaptador de tres vías 1/2"(F)* 3/8"(M)
- 1 Articulación universal 1/2"
- 1 Articulación universal 1/4"
- 2 Barras de extensión 1/2": 150 mm (5") 250 mm (10")
- 2 Barras de extensión 1/4": 50 mm (2") 100 mm (4")
- 18pcs 1/2" Vaso hexagonal: 10,11,12,13,14, 15,16,17,18,19,20,21,22,23,24,27,30,32
- 13 piezas 1/2" Vaso hexagonal: 4 / 4.5 / 5 / 5.5 / 6/7/8/9/10/11/12/13 / 14mm
- 2pcs 1/2" Vaso de bujía: 16 mm / 21 mm
- 1 Cutter manual
- 1 Juego de cuchillas 10pcs
- 1 Barra flexible de extensión de 1/4"x150 mm
- 1 soporte para puntas de 1/4"
- 20 Puntas atornillar: SL3 / SL4 / SL5 / SL6 / PH0 / PH1 / PH2 / PH3 / PZ0 / PZ1 / PZ2 / PZ3 / T10 / T15 / T20 / T30 / H3 / H4 / H5 / H6
- 26 piezas: Tornillo madera de 2,0 mm* 6 piezas / 2,5 mm* 6 piezas; Tornillo autorroscante 2,5 mm* 7 piezas / 5 mm* 7 piezas
- 1 Soporte magnético para brocas

EAN 6941640124791 1unid.

CAJA DE HERRAMIENTAS METÁLICA COD 0062

HTB03

PVP: 34,45 €

404x200x205mm
3 Layers



- Medidas: 404 x 200 x 205 mm

EAN 6928073671979 1unid.

CAJA DE HERRAMIENTAS METÁLICA COD 0063

HTB02

PVP: 46,06 €

495x200x290mm
3 Layers



- Medidas: 495 x 200 x 290 mm

EAN 6928073666869 1unid.

CAJA PLÁSTICO PARA HERRAMIENTAS 14" COD 0888

PBX1401

PVP: 8,58 €

14" 356x168x150mm

Weight:720g



- Medidas: Material polipropileno.
- Peso: 720 g.
- Hebilla de plástico PP
- Carga máxima: 10kg.
- Mango de alta resistencia.
- Cubierta superior con tres áreas de almacenamiento.
- Tapa superior función escalera.
- Contiene 1 bandeja de plástico.

EAN 6941640158970 8unid.

CAJA PLÁSTICO PARA HERRAMIENTAS 17" COD 0889

PBX1701

PVP: 13,17 €

17" 436x220x205mm

Weight:1390g



- Medidas: 436 x 220 x 205mm
- Material polipropileno.
- Peso: 1390 g.
- Hebilla de plástico PP
- Carga máxima: 15kg.
- Mango de alta resistencia.
- Cubierta superior con tres áreas de almacenamiento.
- Tapa superior función escalera.
- Contiene 1 bandeja de plástico.

EAN 6941640156211 8unid.

CAJA PLÁSTICO PARA HERRAMIENTAS 20" COD 0890

PBX2001

PVP: 22,31 €

20" 508x296x261mm

Weight:2150g



- Medidas: 508 x 296 x 261mm
- Material polipropileno.
- Peso: 2150 g.
- Hebilla de plástico PP
- Carga máxima: 20kg.
- Mango de alta resistencia.
- Cubierta superior con tres áreas de almacenamiento.
- Tapa superior función escalera.
- Contiene 1 bandeja de plástico.

EAN 6941640156426 8unid.

2 CAJAS PLÁSTICO PARA HERRAMIENTAS 14" - 17" COD 0891

PBXK0201

PVP: 17,29 €

2PCS/SET



- Medidas: 356 x 168 x 150mm
- Medidas: 436 x 220 x 205mm
- Material polipropileno.
- Peso: 720 - 1390 g.
- Hebilla de plástico PP
- Carga máxima: 10 - 15 kg.
- Mango de alta resistencia.
- Cubierta superior con tres áreas de almacenamiento.
- Tapa superior función escalera.
- Contiene 1 bandeja de plástico.

EAN 6941640178985 6unid.

ORGANIZADOR PLÁSTICO APILABLE 12" COD 1049

PBX1211

PVP: 5,18 €

Size: 30.5cmx23cmx6.5cm

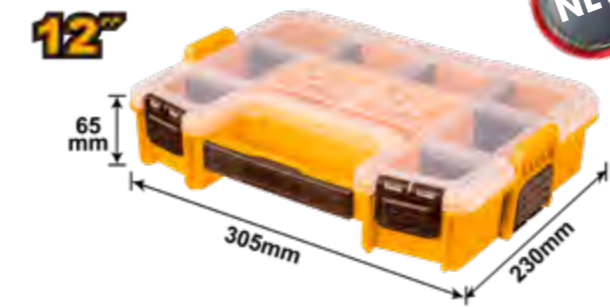

- Medidas: 305 x 230 x 65 mm
- Material polipropileno.
- Apilable.
- Divisores removibles.

EAN 6941640199188 10unid.

ORGANIZADOR PLÁSTICO APILABLE 15" COD 1050

PBX1511

PVP: 6,74 €

Size: 37cmx29cmx6.5cm

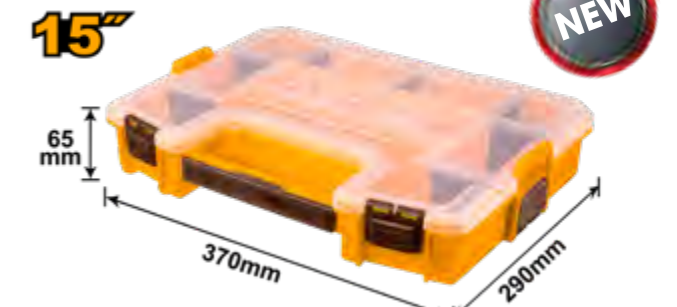

- Medidas: 370 x 290 x 65 mm
- Material polipropileno.
- Apilable.
- Divisores removibles.

EAN 6941640199218 10unid.

BOLSA HERRAMIENTAS 13"

COD 0439

HTBG281328

PVP: 5,94 €



With 6 Pockets
Max Load 12 kgs

- Tela
- Base reforzada
- Máxima apertura, varilla interior
- Medidas: 33 x 18 x 22 cm

EAN 6925582135404 20 unid.

BOLSA PORTAMÁQUINAS INGCO

COD 0546

HTBG281628

PVP: 14,35 €



- Tela
- Base reforzada
- Máxima apertura, varilla interior
- Medidas: 41 x 22 x 27 cm.

EAN 6941640169013 10 unid.

PORTAHERRAMIENTAS

COD 0583

HTBP04011

PVP: 3,24 €



- Poliéster 600 deniers
- Costuras reforzadas
- 4 bolsillos
- Medidas 24 x 13 cm

EAN 6941640119698 6 unid.

PORTAHERRAMIENTAS CON CINTURÓN

COD 0584

HTBP03011

PVP: 6,21 €



- Poliéster 600 deniers
- Costuras reforzadas
- 1 bolsillo grande para taladro
- 5 bolsillos exteriores
- Medidas 29 x 19 cm

With 1pcs Belt

EAN 6941640119681 6 unid.

BOLSA HERRAMIENTAS 16"

COD 0892

HTBG08

PVP: 19,38 €



With 16 Pockets
Max Load 20 kgs

- Medidas: 410 x 250 x 260mm
- Material poliéster 1680D
- Carga máxima: 20kg.
- Máxima apertura, varilla interior.
- Base reforzada.
- Bolsillos interiores para almacenamiento.
- Correa de hombro ajustable incluida.

EAN 6976051780120 10 unid.

BOLSA HERRAMIENTAS 16"

COD 0893

HTBG10

PVP: 30,04 €



With 25 Pockets
Max Load 20 kgs

- Medidas: 460 x 230 x 330mm
- Material poliéster 1680D
- Carga máxima: 20kg.
- 25 bolsillos para herramientas.
- Base reforzada.
- Bolsillos interiores para almacenamiento.
- Correa de hombro ajustable incluida.

EAN 6976051780724 4 unid.

CINTURÓN PORTAHERRAMIENTAS

COD 0456

HTBP02031

PVP: 11,72 €



- Poliéster 600 deniers
- Costuras reforzadas
- 14 bolsillos
- 2 Pcs de 26 x 23 cm y 1 pcs 15 x 13
- Ajustable: 92 - 127 cm

EAN 6925582102932 10 unid.

DELANTAL PORTAHERRAMIENTAS

COD 0455

HTBP01011

PVP: 14,15 €



- Poliéster 600 deniers
- Costuras reforzadas
- 10 bolsillos
- Mosquetón metálico
- Medidas: 32 x 28 cm

EAN 6925582102925 20 unid.

BOLSA HERRAMIENTAS 24"

COD 0894

HTBG09

PVP: 29,54 €



With 18 Pockets
Max Load 25 kgs

- Medidas: 600 x 230 x 350mm
- Material poliéster 1680D
- Carga máxima: 25kg.
- Máxima apertura, varilla interior
- Base reforzada.
- Bolsillos interiores para almacenamiento.
- Correa de hombro ajustable incluida.

EAN 6976051780748 8 unid.

TROLLEY HERRAMIENTAS 20"

COD 0895

HRRTB2015

PVP: 51,92 €



With 19 Pockets
Max Load 20 kgs

- Medidas: 450 x 280 x 360mm
- Tirador telescópico con ruedas.
- Material poliéster 1680D
- Carga máxima: 20kg.
- 5 bolsillos externos.
- Bolsillos interiores para almacenamiento.
- Máxima apertura, varilla interior.

EAN 6976051780106 2 unid.

CHALECO PORTAHERRAMIENTAS

COD 896

HTVT0901

PVP: 18,66 €



42x60x3cm
Max load: 3kg

EAN 6941640158147 20 unid.

MOCHILA PORTAHERRAMIENTAS

COD 0777

HBP01028

PVP: 25,44 €



380x170x460mm
15"x7"x18"
Max Load 8 kgs



- Medidas: 380 x 170 x 460mm
- Carga máxima 8 kg.
- Material poliéster 1680D
- Marco rígido para fácil apertura.
- Bolsillos externos e internos para almacenamiento.

EAN 6976051786238 20 unid.

ALICATE UNIVERSAL
HHCP28160
COD 1051
PVP: 6,08 €



- Mango largo 30% más de fuerza
- 160 mm

EAN 6942141801082 6 unid.

ALICATE UNIVERSAL
HHCP28180
COD 0234
PVP: 7,56 €



- Mango largo 30% más de fuerza
- 180 mm

EAN 6925582122770 6 unid.

ALICATE CORTE DIAGONAL
HHLDCP28160
COD 0380
PVP: 5,98 €



- Mango largo 30% más de fuerza
- 160 mm

EAN 6925582122787 6 unid.

ALICATE CORTE DIAGONAL
HHLDCP28180
COD 0382
PVP: 6,44 €



- Mango largo 30% más de fuerza
- 180 mm

EAN 6925582117585 6 unid.

ALICATE UNIVERSAL
HHCP28200
COD 0381
PVP: 7,70 €



- Mango largo 30% más de fuerza
- 200 mm

EAN 6925582117578 6 unid.

ALICATE UNIVERSAL
HHCP28240
COD 0346
PVP: 10,24 €



- Tamaño: 9.5" / 240 mm
- CR-V, acabado pulido en negro
- TPR mango de dos colores
- Mango largo 30% más de fuerza

EAN 6925582120615 6 unid.

ALICATE CORTE DIAGONAL
HHHDCP28180
COD 0383
PVP: 6,90 €



- Mango largo 30% más de fuerza
- 180 mm

EAN 6925582123098 6 unid.

ALICATE BOCA SEMI REDONDA LARGA
HHLNP28160
COD 0231
PVP: 6,44 €



- Mango fibra INGCO
- Mango largo 30% más de fuerza
- 160 mm

EAN 6925582117592 6 unid.

ALICATE CORTE FRONTAL
HECP28160
COD 0778
PVP: 6,24 €



- Mango largo 30% más de fuerza
- 160 mm

EAN 692807367110 36 unid.

ALICATE CORTE FRONTAL
HECP28200
COD 1052
PVP: 7,10 €



- Mango largo 30% más de fuerza
- 200 mm

EAN 6941640172303 36 unid.

ALICATE BOCA SEMI REDONDA LARGA
HHLNP28200
COD 0235
PVP: 6,60 €



- Mango fibra INGCO
- Mango largo 30% más de fuerza
- 200 mm

EAN 6925582122596 6 unid.

MINI CORTAVARILLAS
HMBC0808
COD 0457
PVP: 4,80 €



- Mango fibra INGCO
- Medida: 200 mm

EAN 6925582121551 6 unid.

ALICATE PRO MULTIFUNCIONES 8 EN 1

COD 1053

HMFCP28200

PVP: 11,22 €



CrV 8 IN 1
200mm(8")



- Mango largo 65% más de fuerza
- Revestimiento de teflón
- 200 mm
- Funciones: Crimpadora, desbaste, corte, cizalla tornillos, agarre dentado circular, guía clavos, pela cables, agarre cables.

EAN 6976051782865 36 unid.

JUEGO ALICATES 3 PCS

COD 0066

HKPS28318

PVP: 16,00 €

160mm(6")
160mm(6")
200mm(8")

3PCS/SET



- Alicate universal 8" 200 mm
- Alicate corte diagonal 6" 160 mm
- Alicate boca semi-redonda 6" 160 mm

EAN 6925582120547 5 unid.

JUEGO ALICATES

COD 0279

HKHLPS2831

PVP: 17,12 €

160mm(6")
180mm(7")
200mm(8")

3PCS/SET



- Alicate universal 200 mm
- Alicate corte diagonal 160 mm
- Alicate punta larga: 160 mm
- Mango largo con un 30% más de fuerza



EAN 6925582118032 5 unid.

ALICATE PRO UNIVERSAL

COD 1054

HCCP58200

PVP: 10 €

65%
Energy Saving

CrV 200mm(8")



- Mango largo 65% más de fuerza
- Revestimiento de teflón
- 200 mm
- Funciones: Desbaste, agarre dentado circular, guía clavos



EAN 6976051783145 36 unid.

ALICATE PRO CORTE DIAGONAL

COD 1055

HDCDP58200

PVP: 9,78 €

65%
Energy Saving

CrV 200mm(8")



- Mango largo 65% más de fuerza
- Revestimiento de teflón
- 200 mm



EAN 6976051782131 36 unid.

JUEGO MINI-ALICATES 6 PCS

COD 0067

HMPS06115

PVP: 16,14 €

115mm(4.5")

6PCS/SET



- Alicate universal
- Alicate corte diagonal
- Alicate corte frontal
- Alicate boca plana
- Alicate boca semi-redonda
- Alicate boca semi-redonda larga
- Mango fibra INGCO

EAN 6941640112613 5 unid.

ALICATE PELACABLES

COD 0384

HWSP28160

PVP: 6,00 €

CrV 160mm(6")



- Mango fibra INGCO
- Medida: 160 mm

EAN 6928073680148 6 unid.

ALICATE PRO BOCA SEMI REDONDA LARGA

COD 1056

HCLNP58200

PVP: 9,40 €

65%
Energy Saving

CrV 215mm(8.5")



- Mango largo 65% más de fuerza
- Revestimiento de teflón
- 215 mm



EAN 6976051783176 36 unid.

ALICATE PRO CORTE FRONTAL

COD 1057

HCECP58200

PVP: 10,92 €

65%
Energy Saving

CrV 215mm(8.5")



- Mango largo 65% más de fuerza
- Revestimiento de teflón
- 215 mm



EAN 6976051783183 36 unid.

PELACABLES 0,5 - 6 MM

COD 0107

HWSP15608

PVP: 8,28 €

178mm(7")



- Función de corte incorporada

EAN 6925582118285 12 unid.

CRIMPADORA MULTIFUNCION 4 EN 1

COD 1058

HWSP102429

PVP: 20,69 €



- Detección de voltaje sin contacto.
- Corta cables de cobre y aluminio.
- Pela cables 0,2 - 6 mm²
- Crimpadora 0,5 - 6 mm²
- 2 pilas LR44 incluidas



EAN 6941640165756 48 unid.

TIJERA ELECTRICISTA COD 0525

HES02855 PVP: 2,80 €

- Cuchillas acero inoxidable 3mm
- Medida 145mm
- Mango ABS ergonómico



EAN 6925582149081 25 unid.

TIJERA ELECT. AISLADA COD 0630

HIS1601 PVP: 16,76 €

- Aislado 1000 V
- Certificado VDE
- Medida 160 mm
- Mango ABS ergonómico



EAN 6941640165572 72 unid.

ALICATE UNIVERSAL ELECTRICISTA COD 0594

HICP28188 PVP: 8,92 €



- Aislado 1000 V
- Certificado VDE
- 180 mm

EAN 6925582139006 6 unid.

ALICATE CORTE DIAGONAL ELECTRICISTA COD 0596

HIHDCP28160 PVP: 8,68 €



- Aislado 1000 V
- Certificado VDE
- 160 mm

EAN 6925582138979 6 unid.

ALICATE UNIVERSAL ELECTRICISTA COD 0593

HICP28168 PVP: 8,22 €



- Aislado 1000 V
- Certificado VDE
- 160 mm

EAN 6925582138931 6 unid.

ALICATE UNIVERSAL ELECTRICISTA COD 0595

HICP28208 PVP: 9,84 €



- Aislado 1000 V
- Certificado VDE
- 200 mm

EAN 6925582138986 6 unid.

ALICATE CORTE DIAGONAL ELECTRICISTA COD 0597

HIHDCP28188 PVP: 9,08 €



- Aislado 1000 V
- Certificado VDE
- 180 mm

EAN 6925582138993 6 unid.

ALICATE CORTA CABLES ELECTRICISTA COD 1059

HICCB28160 PVP: 7,18 €



- Aislado 1000V
- Certificado VDE
- 160 mm

EAN 6925582138924 36 unid.

ALICATE ARO SEEGER EXTERIOR RECTO COD 0779

HCCP261801 PVP: 4,82 €



- Alicates para aros seeger de cabeza recta
- Pinza para arandelas exteriores

EAN 6941640161901 6 unid.

Tamaño: 7"/180 mm

Diámetro de la cabeza: 1,8 mm

ALICATE ARO SEEGER INTERIOR RECTO COD 0781

HCCP261803 PVP: 4,82 €



- Alicates para aros seeger de cabeza recta
- Pinza para arandelas interiores

EAN 6941640164452 6 unid.

Tamaño: 7"/180 mm

Diámetro de la cabeza: 1,8 mm

JUEGO ALICATES 3 PCS ELECTRICISTA COD 0598

HIKPS28318 PVP: 25,32 €



- Aislado 1000 V
- Certificado VDE
- Alicates universal 200mm
- Alicates corte diagonal 160mm
- Alicates boca semi redonda 160mm

EAN 6925582145984 5 unid.

ALICATE ARO SEEGER EXTERIOR ACODADO COD 0780

HCCP261802 PVP: 4,82 €



- Alicates para aros seeger de cabeza acodada
- Pinza para arandelas exteriores

EAN 6941640154224 6 unid.

Tamaño: 7"/180 mm

Diámetro de la cabeza: 1,8 mm

ALICATE ARO SEEGER INTERIOR ACODADO COD 0782

HCCP261804 PVP: 4,82 €



- Alicates para aros seeger de cabeza acodada
- Pinza para arandelas interiores

EAN 6941640156778 6 unid.

Tamaño: 7"/180 mm

Diámetro de la cabeza: 1,8 mm

JUEGO ALICATE AROS SEEGER

COD 0068

HCCPS01180

PVP: 17,88 €



- Aislado 1000V
- Certificado VDE
- 160 mm

EAN 6925582101621 30 unid.

TENAZA PICO LORO

COD 0458

HPP28251

PVP: 7,98 €



- Mango fibra INGCO

EAN	6925582132281	6 unid.
Longitud	250 mm	
Apertura máx.	50 mm	

TENAZA PICO LORO

COD 0233

HPP28258

PVP: 7,98 €



- Mango fibra INGCO

EAN	6925582130720	6 unid.
Longitud	250 mm	
Apertura máx.	40 mm	

TENAZA RUSA



COD	Largo	EAN	PVP	
0264	HRP02200	200mm	6928073675472	5,12
0265	HRP02250	250mm	6928073675496	6,96

MORDAZA CURVA ALICATES DE BLOQUEO

COD 0236

HCJLW0110

PVP: 9,68 €



- Cr-V
- HRC52 - HRC60
- Níquel plateado

EAN 6925582100617 5 unid.
Tamaño 10"

MORDAZA SEMI CURVA ALICATES DE BLOQUEO

COD 0385

HSJP0110

PVP: 6,14 €



- Cr-V
- Níquel plateado

EAN 6925582100648 5 unid.
Tamaño 10"

MARTILLO MAQUINISTA



- Mango fibra de vidrio INGCO

PESO	EAN	REF	COD	6	PVP
100 g	6941640160652	HMHS81001	0386	6	3,36 €
200 g	6925582123715	HMH880200	0387	6	3,64 €
300 g	6941640158116	HMHS83001	0388	6	4,26 €
500 g	6925582122114	HMH880500	0389	6	5,74 €
1.000 g	6925582122121	HMH881000	0390	4	8,92 €
1.500 g	6925582122138	HMH881500	0391	4	11,98 €

MARTILLO DE BOLA



- Mango fibra de vidrio INGCO

PESO	EAN	REF	COD	6	PVP
16 oz / 450 g	6941640150431	HBPHS8016	0222	6	6,00 €
24 oz / 660 g	6925582122909	HBPH88024	0223	6	7,72 €

MARTILLO DE OREJAS



- Mango fibra de vidrio INGCO

PESO	EAN	REF	COD	6	PVP
8 oz / 220 g	6941640165763	HCHS8008	0414	6	4,35 €
16 oz / 450 g	6941640152978	HCHS8016	0221	6	6,10 €
20 oz / 560 g	6925582146219	HCH80820	0585	6	7,02 €

MARTILLO CAUCHO Y PLÁSTICO

COD 0226

HRPH8140

PVP: 8,86 €



- Diámetro martillo: 40 mm
- Mango fibra de vidrio INGCO

EAN 6928073713259 10 unid.

MAZA DE GOMA



- Mango fibra de vidrio INGCO

PESO	EAN	REF	COD	10	PVP
8 oz / 220 g	6925582105704	HRUH8208	0224	10	3,80 €
16 oz / 450 g	6925582105711	HRUH8216	0225	6	5,16 €

MAZA DE GOMA BLANCA



- Mango fibra de vidrio INGCO

PESO	EAN	REF	COD	6	PVP
8 oz / 220 g	6928073713549	HRUH8308	0586	6	5,52 €
16 oz / 450 g	6925582105735	HRUH8316	0587	4	7,72 €

MACETA



- Cabeza forjada
- Mango fibra de vidrio INGCO

PESO	EAN	REF	COD	Unid.	PVP
1.000 g	6941640163226	HSTHS81000	0305	6	8,08 €
1.500 g	6925582122886	HSTH8803	0306	4	11,32 €
2.000 g	6925582122893	HSTH8804	0307	4	13,36 €

MAZA DOS MANOS 5 KG (900 mm)

HSTH03598

COD 0228

PVP: 37,46 €



- Peso: 5 kg
- Mango fibra de vidrio INGCO

EAN	6925582119299	Unid.	4 unid.
-----	---------------	-------	---------

CINCEL

HCCL082210

COD 0247

PVP: 3,24 €



- Empuñadura INGCO
- Acero forjado

EAN	6925582117257	Unid.	6 unid.
Ancho pala	22 mm		
Diámetro varilla	16 mm		
Longitud	250 mm		

MAZA DOS MANOS 4 KG (900 mm)

HSTH03498

COD 0392

PVP: 32,94 €



- Peso: 4 kg
- Mango fibra de vidrio INGCO

EAN	6925582119282	Unid.	4 unid.
-----	---------------	-------	---------

HACHA

HAXS206001

COD 0227

PVP: 9,30 €



- Peso de la cabeza: 600 g
- Tratamiento térmico de martillo forjado en 45 de fibra de vidrio de acero al carbono
- Longitud: 360 mm

EAN	6941640168061	Unid.	6 unid.
-----	---------------	-------	---------

CINCEL

HCCL082412

COD 0248

PVP: 4,22 €



- Empuñadura INGCO
- Acero forjado

EAN	6925582117189	Unid.	6 unid.
Ancho pala	25 mm		
Diámetro varilla	18 mm		
Longitud	300 mm		

CINCEL

HCCL851916

COD 0588

PVP: 5,34 €



- Empuñadura INGCO PRO
- Acero forjado
- Ancho pala 19mm
- Diámetro varilla 16mm
- Longitud 305mm

EAN	6925582144987	Unid.	5 unid.
Ancho pala	19 mm		
Diámetro varilla	16 mm		
Longitud	305 mm		

PUNTERO

HCC850419

COD 0685

PVP: 6,48 €



- Empuñadura INGCO PRO
- Acero forjado
- Diámetro varilla 19mm
- Longitud 305 mm

EAN	6925582145410	Unid.	24 unid.
-----	---------------	-------	----------

CORTADOR CERÁMICA

HTC04800AG

COD 0349

PVP: 129,04 €



- Bolsa transporte
- Placa de aluminio
- Corte de línea diagonal
- Con indicador de aluminio
- 2Pcs de soporte de acero
- Embalado en caja de cartón
- Multifunción: corte de línea directa,
- 1Pcs de carburo tungsteno tamaño: 22 x 10,5 x 2 mm

EAN	6925582121162	Unid.	1 unid.
Longitud máxima de corte	800 mm		
Espesor máximo de corte	14 mm		
Tamaño de corte	800 mm		
Espesor base	2,5 mm		
Tamaño cuchilla	16 x 6 x 3 mm		
Tamaño de la base	993 x 165 mm		

CINCEL

HCCL852519

COD 0589

PVP: 6,48 €



- Empuñadura INGCO PRO
- Acero forjado
- Ancho pala 25mm
- Diámetro varilla 19mm
- Longitud 305mm

EAN	6925582145403	Unid.	5 unid.
Ancho pala	25 mm		
Diámetro varilla	19 mm		
Longitud	305 mm		

CORTADOR CERÁMICA

HTC04600

COD 0347

PVP: 51,28 €



- Cortador de azulejos
- Con 2 Pcs de hoja de carburo de tungsteno
- Multifunción: corte de línea directa corte de línea diagonal

EAN	6925582104455	Unid.	4 unid.
Longitud máxima de corte	600 mm		
Espesor máximo de corte	12 mm		
Tamaño base	815 x 195 cm		
Espesor base	2 mm		
Tamaño cuchilla	16 x 6 x 3 mm		
Diámetro de barra deslizante	19 mm		

CORTADOR CERÁMICA

HTC041200

COD 1060

PVP: 149,72 €



- Placa aluminio
- Corte de línea diagonal
- Indicador de aluminio
- 2 pcs soporte de acero

EAN	6976051783640	Unid.	1 unid.
Longitud máxima de corte	1200mm		
Espesor máximo de corte	12mm		
Medidas base	1460 x 260 mm		
Espesor base	2mm		

PALANCA DESENCOFRADOR



- Gancho y palanca con uñas biseladas
- Barra de acero forjado templado para mayor durabilidad
- Su diseño trilobular potencia su dureza, resistencia y facilidad de uso

MEDIDAS	EAN	REF	COD	10 unid.	PVP
35 cm	6928073713808	HWBA01142	0459	6	4,30 €
60 cm	6928073711620	HWBA01242	0460	6	10,14 €
90 cm	6928073713815	HWBA01362	0461	6	14,62 €

PALETA MODELO MADRID **COD 0464**
HBT738 **PVP: 3,84 €**



- Medida: 180 mm
- Mango fibra INGCO

EAN	6925582127294	12 unid.
-----	---------------	----------

LLANA RECTA INOXIDABLE **COD 0466**
HPT28138S **PVP: 7,24 €**



EAN	6925582123036	10 unid.
Medidas	280 x 130 mm	

PALETA



- Mango fibra INGCO

MEDIDAS	EAN	REF	COD	10 unid.	PVP
150 mm	6925582118063	HBT618	0462	10	2,48 €
180 mm	6925582118100	HBT718	0463	10	2,98 €

PALETA MODELO NORTE **COD 0465**
HBT748 **PVP: 4,06 €**



- Medida: 180 mm
- Mango fibra INGCO

EAN	6925582123210	12 unid.
-----	---------------	----------

LLANA DENTADA INOXIDABLE **COD 0467**
HPPT28138S **PVP: 7,36 €**



EAN	6925582123043	10 unid.
Medidas	280 x 130 mm	
Dientes	10 mm	

LLANA DE GOMA ESPONJA

HSFR24108 **COD 0591**
PVP: 7,84 €



- Base de aluminio y goma blanda

EAN	6925582128147	10 unid.
Medidas	240 x 100 mm	

LLANA ACERO **COD 0686**
HPT231025 **PVP: 3,58 €**



- Medidas 230 x 100 mm

EAN	6941640153081	10 unid.
Medidas	240 x 100 mm	

LLANA DE GOMA

HSFR24008 **COD 0592**
PVP: 7,04 €



- Base de aluminio y esponja

EAN	6925582127485	10 unid.
Medidas	230 x 100 mm	
Dientes	10 mm	

LLANA DENTADA ACERO **COD 0687**
HPTT231025 **PVP: 4,14 €**



- Medidas 230 x 100 mm
- Diente 10 x 6 mm

EAN	6941640160768	10 unid.
Medidas	230 x 100 mm	
Dientes	10 mm	

MARCADOR TIRALINEAS + AZULETE

HCLR0130 **COD 0147**
PVP: 4,72 €



- Acc: nivel
- Marcador 30 m + Bote azul

EAN	6928073668399	10 unid.
-----	---------------	----------

SARGENTO MONOMANUAL



- Fuerza máx. Mordaza: 170 Kg
- Medida varilla: 5 x 15 mm
- Diámetro rosca: 11 mm

MEDIDAS	EAN	REF	COD		PVP
50 x 150 mm	6928073664360	HFC020501	0468	10	4,56 €
50 x 200 mm	6928073664377	HFC020502	0469	10	4,76 €
50 x 250 mm	6928073664384	HFC020503	0470	10	4,92 €

SARGENTO MONOMANUAL

HFC020802

COD 0471

PVP: 8,28 €



- Fuerza máx. Mordaza: 270 Kg
- Medida varilla: 6 x 22 mm
- Diámetro rosca: 13,5 mm

EAN	6928073664025		10 unid.
Medidas			80 x 300 mm

SARGENTO MONOMANUAL



- Fuerza máx. Mordaza: 450 Kg
- Medida varilla: 8 x 30 mm
- Diámetro rosca: 15,3 mm

MEDIDA	EAN	REF	COD		PVP
120 x 300 mm	6928073664032	HFC021201	0472	6	13,20 €
120 x 400 mm	6928073662854	HFC021204	0473	6	14,20 €
120 x 500 mm	6928073662908	HFC021202	0474	6	15,48 €
120 x 600 mm	6925582117721	HFC021205	0475	6	16,24 €
120 x 800 mm	6928073662915	HFC021203	0476	6	18,78 €

SARGENTO MONOMANUAL

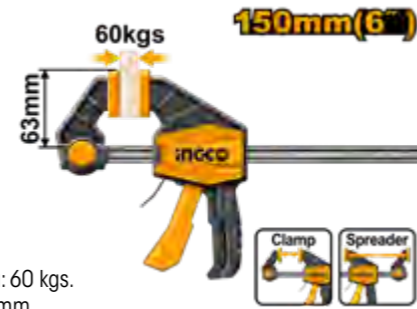

- Fuerza máx. mordaza: 60 kgs.
- Medida varilla: 5x18 mm

MEDIDAS	EAN	REF	COD		PVP
63x150 mm	6925582146806	HQBC01601	0615	10	5,34 €
63x300 mm	6925582146813	HQBC01602	0616	10	6,38 €
63x450 mm	6925582146820	HQBC01603	0617	10	7,36 €

SARGENTO MONOMANUAL



- Fuerza máx. Mordaza: 135 Kg
- Medida varilla: 6 x 18 mm

MEDIDAS	EAN	REF	COD		PVP
80 x 450 mm	6941640161680	HQBC18801	0688	12	17,12 €
80 x 600 mm	6941640166807	HQBC24802	0689	8	18,54 €
80 x 900 mm	6941640154019	HQBC36803	0690	8	21,98 €

PINZA SUJECIÓN



PVP: 1,19 €

- Fuerza máx. mordaza: 12 kgs
- Máx. apertura: 50 mm
- 110 mm

MEDIDAS	EAN	REF	COD	
50 x 110 mm	6925582142440	HQSC0204	0618	10



PVP: 1,70 €

- Fuerza máx. mordaza: 15 kgs
- Máx. apertura: 68 mm
- 150 mm

MEDIDAS	EAN	REF	COD	
50 x 150 mm	6925582142433	HQSC0206	0619	10

TORNILLO DE BANCO CON YUNQUE



- Giratorio 360°
- Medida: 200 mm
- Peso: 21 kg
- Fuerza máx. Mordaza: 2.500 kg

MEDIDAS	EAN	REF	COD		PVP
50 x 100 mm	6925582125825	HBV084	0477	1	47,38 €
50 x 150 mm	6925582127263	HBV086	0478	1	79,00 €
50 x 200 mm	6925582128901	HBV088	0479	1	138,76 €

LIMA METAL PLANA

HSFF088P

COD 0791

PVP: 3,84 €

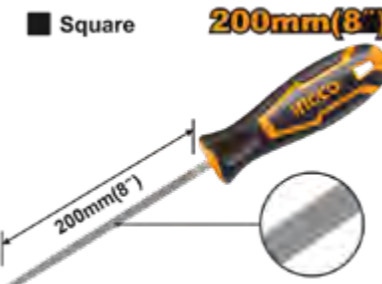

- Acero T12

EAN	6925582125443		12 unid.
Longitud			200 mm

LIMA METAL TRIANGULAR

HSTF088P

COD 0794

PVP: 3,70 €

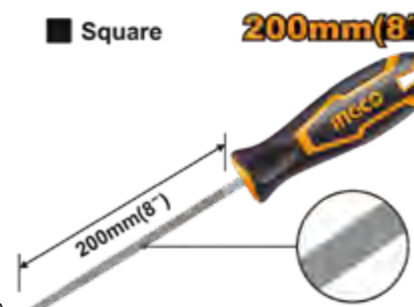

- Acero T12

EAN	6925582125436		12 unid.
Longitud			200 mm

TORNILLO DE BANCO

HBV082

COD 0590

PVP: 17,60 €



- Giratorio 360°
- Medida base 60 mm
- Peso 1,7 kg
- Fuerza máx. Mordaza: 1000 kg

EAN	6925582142525		1 unid.
-----	---------------	--	---------

LIMA METAL MEDIA CAÑA

HSHF088P

COD 0792

PVP: 4,42 €

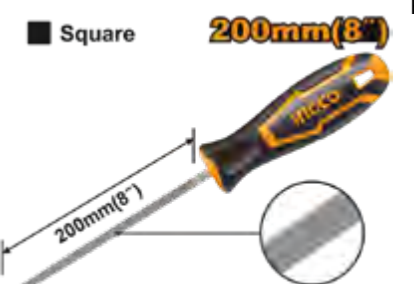

- Acero T12

EAN	6925582125412		12 unid.
Longitud			200 mm

LIMA METAL REDONDA

HSRF088P

COD 0793

PVP: 3,30 €

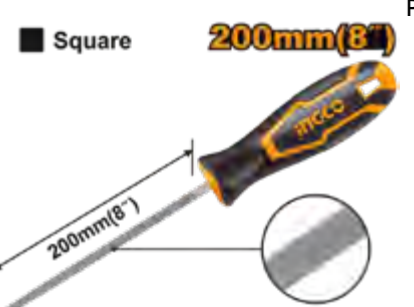

- Acero T12

EAN	6925582125429		12 unid.
Longitud			200 mm

LIMA METAL CUADRADA

COD 0795

HSSF088 **■ Square** **200mm(8")** PVP: 3,46 €

• Acero T12

EAN	6925582100501	12 unid.
Longitud	200 mm	

JUEGO LIMAS

200mm(8") 3Pcs File Set **200mm(8") 5Pcs File Set**

MEDIDAS	EAN	REF	COD	unid.	PVP
3 x 8" 200 mm	6925582101249	HKTF51308	143	10	11,55 €
5 x 8" 200 mm	6925582101232	HKTF50508	144	5	18,54 €

FORMÓN MADERA

Ancho	Longitud	EAN	REF	COD	unid.	PVP
6MM	6 mm	6928073672662	HWC0806	0783	12	4,16 €
9MM	9 mm	6928073672679	HWC0809	0784	12	4,22 €
12mm	12 mm	6928073672686	HWC0812	0785	12	4,40 €
14mm	14 mm	6928073672693	HWC0814	0786	12	4,48 €
16MM	16mm	6928073672709	HWC0816	0787	12	4,55 €
19MM	19mm	6928073672716	HWC0819	0788	12	4,60 €
22MM	22mm	6928073672723	HWC0822	0789	12	4,76 €
25MM	25mm	6928073672730	HWC0825	0790	12	4,92 €

JUEGO DE LIMATONES

COD 0146

HKTF63 **140mm(5.5") 6Pcs File Set** PVP: 4,26 €

• Juego de 6 limatones 3 x 140 mm

EAN	6925582108514	12 unid.
-----	---------------	----------

JUEGO DE ESCOFINAS

COD 0145

HKTFW0308 **200mm(8") 3Pcs File Set** PVP: 10,50 €

Juego de 3 escofinas para madera 8" 200 mm

EAN	6925582101225	10 unid.
-----	---------------	----------

JUEGO DE FORMONES

COD 0115

HKTWC0401 **4PCS/SET** PVP: 16,20 €

• Formones 6 mm / 12 mm / 19 mm / 25 mm

EAN	6928073711682	4 unid.
-----	---------------	---------

DESTORNILLADOR DE PUNTA PLANA 6,5 X 38

COD 0237

HS686038 PVP: 1,42 €

SL6.5X38mm **S2**

• Punta plana

EAN	6941640126825	12 unid.
Ancho	6,5 mm	
Longitud	38 mm	

DESTORNILLADOR PHILLIPS PH2 X 38

COD 0241

HS68PH2038 PVP: 1,38 €

PH2X38mm **S2**

• PH2

EAN	6941640126696	12 unid.
Diámetro	6,0 mm	
Longitud	38 mm	

DESTORNILLADOR POZIDRIV

PZ1X100mm **S2**

• Punta pozidriv

MODELO	EAN	REF	COD	unid.	PVP
PZ1 x 100	6941640144911	HS68PZ1100	0413	12	1,32 €
PZ2 x 150	6941640141934	HS68PZ2150	0246	12	1,86 €

DESTORNILLADOR PUNTA PLANA

	EAN	REF	COD	unid.	PVP
4 x 100 mm	6941640126702	HS684100	0238	12	1,18 €
5,5 x 75 mm	6941640126733	HS685075	0239	12	1,28 €
5,5 x 100 mm	6941640126757	HS685100	0393	12	1,32 €
6,5 x 125 mm	6941640126771	HS686125	0240	12	1,78 €
8 x 150 mm	6941640168764	HS688150	0394	12	2,64 €

DESTORNILLADOR PHILLIPS

	EAN	REF	COD	unid.	PVP
3 X 75 mm PH0	6941640126726	HS68PH0075	0242	12	0,96 €
5 x 75 mm PH1	6941640126740	HS68PH1075	0243	12	1,28 €
6 x 125 mm PH2	6941640126764	HS68PH2125	0244	12	1,78 €
8 x 150 mm PH3	6941640165794	HS68PH3150	0245	12	2,64 €

DESTORNILLADOR TORX

	EAN	REF	COD	unid.	PVP
6 X 75 mm	6976051781066	HSDT06075	0796	12	0,80 €
7 x 75 mm	6976051781073	HSDT07075	0797	12	0,80 €
8 x 75 mm	6976051781080	HSDT08075	0798	12	0,80 €
9 x 75 mm	6976051781097	HSDT09075	0799	12	0,80 €
10 x 75 mm	6976051781103	HSDT10075	0800	12	0,80 €
10 x 100 mm	6976051781110	HSDT10100	0801	12	1,08 €
15 x 100 mm	6976051781127	HSDT15100	0802	12	1,08 €
20 x 150 mm	6976051781134	HSDT20150	0803	12	1,42 €
25 x 150 mm	6976051781141	HSDT25150	0804	12	1,42 €
27 x 150 mm	6976051781158	HSDT27150	0805	12	1,42 €
30 x 150 mm	6976051781165	HSDT30150	0806	12	1,42 €
40 x 150 mm	6976051781172	HSDT40150	0807	12	1,98 €

JUEGO DESTORNILLADORES 6 PCS

COD 0088

HKSD0628

PVP: 6,38 €



- Destornillador punta plana 5,5 x 75 / 5,5 x 100 / 6,5 x 150 mm
- Destornillador punta PHILLIPS 1 x 75 / 1 x 100 / 2 x 150 mm

EAN 6928073680261 5 unid.

JUEGO DESTORNILLADORES 8 PCS

COD 0090

HKSD0828

PVP: 13,12 €



- Destornillador punta plana 3 x 75 / 5 x 100 / 6 x 150 / 6 x 38 mm
- Destornillador punta PHILLIPS 0 x 75 / 1 x 75 / 2 x 125 / 2 x 38 mm

EAN 6925582104462 5 unid.

JUEGO DESTORNILLADORES 10 PCS

COD 0091

HKSD1028

PVP: 21,65 €



- Destornillador punta plana 3 x 75 / 4 x 100 / 5,5 x 125 / 6,5 x 150 / 8 x 200 / 6 x 38 mm
- Destornillador punta PHILLIPS 0 x 60 / 1 x 80 / 2 x 100 / 3 x 150 mm

EAN 6925582104486 5 unid.

JUEGO DESTORNILLADORES 18 PCS

COD 0092

HKSD1828

PVP: 24,95 €



- Set de precisión
- Destornillador punta plana 5,5 x 75 / 6,5 x 100 / 8 x 150 / 6 x 38 mm
- Destornillador punta PHILLIPS 1 x 75 / 2 x 100 / 3 x 150 / 2 x 38 mm

EAN 6925582104479 5 unid.

DESTORNILLADOR ELECTRICISTA PLANO



- Aislado 1000V
- Certificado VDE

	EAN	REF	COD	unid	PVP
3 x 75 mm	6928073712146	HISD813075	0395	144	1,58 €
4 x 100 mm	6928073680728	HISD814100	0396	144	1,78 €
5,5 x 125 mm	6928073680735	HISD815125	0397	144	2,14 €
6,5 x 150 mm	6928073680742	HISD816150	0398	144	2,64 €

DESTORNILLADOR ELECTRICISTA POZIDRIV



- Aislado 1000V
- Certificado VDE

	EAN	REF	COD	unid	PVP
PZ1 x 180 mm	6925582143065	HISD81PZ180	0885	144	1,82 €
PZ2 x 100 mm	6928073680780	HISD81PZ2100	0886	144	2,34 €

JUEGO DESTORNILLADORES PUNTAS INTERCAMBIABLES

COD 1061

HKISD1201

PVP: 31,22 €



- Aislado 1000V
- Certificado VDE
- Punta plana: 2-2,5-3-3,5-4-5,5-6,5 x 100 mm
- Punta phillips: PH0-PH1-PH2 x 100 mm
- Detector de corriente
- Estuche enrollable tela.

EAN 6941640137357 48 unid.

DESTORNILLADOR ELECTRICISTA PHILLIPS



- Aislado 1000V
- Certificado VDE

	EAN	REF	COD	unid	PVP
PH0 x 60 mm	6928073680759	HISD81PH060	0399	144	1,58 €
PH1 x 80 mm	6928073680766	HISD81PH180	0400	144	1,78 €
PH2 x 100 mm	6928073680773	HISD81PH2100	0401	144	2,64 €

JUEGO DE 6 DESTORNILLADORES ELECTRICISTA

COD 0402

HKISD0608

PVP: 16,78 €



- Aislado 1000 V
- Certificado VDE
- Destornillador punta plana 3 x 75 / 4 x 100 / 6,5 x 150 mm
- Destornillador punta PHILLIPS 0 x 60 / 1 x 80 / 2 x 150 mm

EAN 6928073680797 6 unid.

JUEGO 6 HERRAMIENTAS ELECTRICISTA

COD 1062

HKIST3061

PVP: 22,58 €



- Aislado 1000V
- Certificado VDE
- 1 Destornillador plano 5,5 x 125 mm
- 1 Destornillador plano 4 x 100 mm
- 1 Destornillador phillips PH2 x 100 mm
- 1 Alicata universal de 180 mm
- 1 Alicata corte diagonal de 160 mm
- 1 Detector corriente 100-500 V AC

EAN 6941640133892 24 unid.

JUEGO DESTORNILLADORES DE TUERCAS HEXAGONALES COD 1063
HKISD0701 PVP: 51,90 €



- Aislado 1000V
- Certificado VDE
- Medidas: 6x125 / 7x125 / 8x125 / 9x125
- 10x125 / 11x125 / 12x125mm

EAN 6941640145031 20 unid.

JUEGO DESTORNILLADORES 2 PCS COD 0087
HKSD0248 PVP: 2,38 €



- Destornillador punta plana 6,5 x 100 mm
- Destornillador punta PHILLIPS 2 x 100 mm

EAN 6925582111910 10 unid.

JUEGO DESTORNILLADORES PRECISIÓN COD 0096
HKSD0718 PVP: 5,94 €



- 7 destornilladores

EAN 6925582104189 6 unid.

DESTORNILLADOR 13 EN 1 COD 0097
AKISD1208 PVP: 5,24 €



- Destornillador con puntas intercambiables
- Puntas incluidas

EAN 6925581122374 12 unid.

DESTORNILLADOR 2 EN 1 REVERSIBLE COD 0093
AKISD0201 PVP: 2,22 €



- Destornillador punta plana 6,5 x 160 mm
- Destornillador punta PHILLIPS PH2 x 160 mm

EAN 6928073683729 12 unid.

DESTORNILLADOR 6 EN 1 COD 0094
AKISD0608 PVP: 3,50 €

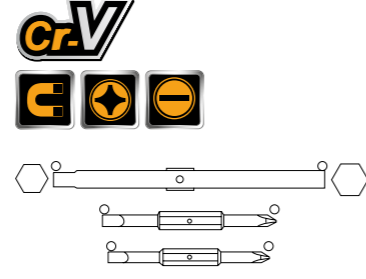

- Mango con punta intercambiable
- Puntas incluidas

EAN 6925582117295 18 unid.

DESTORNILLADOR MANGO T COD 0098
HKSD0188 PVP: 6,20 €



- Puntas y vasos intercambiables

EAN 6925582117059 6 unid.

DESTORNILLADOR 24 PCS COD 0099
HKSD0248 PVP: 7,88 €



- Mango destornillador + 24 puntas

EAN 6925582117332 6 unid.

DESTORNILLADOR 8 EN 1 COD 1064
AKISD0808 PVP: 4,40 €



- Mango destornillador carraca.
- 7 puntas de 25mm: SL5,SL6,PH1,PH2,PH3,T15,T20.

EAN 6925582118216 72 unid.

JUEGO DESTORNILLADORES 9 PCS COD 0095
AKISD0901 PVP: 6,86 €



- Mango intercambiable

EAN 6928073673485 12 unid.

JUEGO DESTORNILLADOR 26 PCS COD 0102
HKSD0268 PVP: 14,66 €



- Mango destornillador + 26 accesorios

EAN 6925582104134 6 unid.

JUEGO DESTORNILLADOR 33 PCS COD 0101
HKSD0338 PVP: 17,26 €



- Mango destornillador + 33 accesorios

EAN 6925582117516 6 unid.

BLISTER 2 PORTAPUNTAS

ABH10601

COD 0298

PVP: 2,84 €



- 2 Piezas de 60 mm

EAN 6928073669075 25 unid.

PORTAPUNTAS PARA PLADUR

ABH50608

COD 1065

PVP: 4,29 €



- Con tope de profundidad.
- Medida 60mm
- Hexagonal 1/4"

EAN 6941640196279 400 unid.



PORTAPUNTAS + 9 PUNTAS

AKSD0071

COD 0299

PVP: 3,24 €



- 9 Puntas
- PH1 / PH2 / PH3 / SL4.0 / SL5.5 / SL6.5 / PZ1 / PZ
- Puntas imantadas
- Material: acero CR-V
- Portapuntas con anclaje

EAN 6928073675229 25 unid.

SET 29 PUNTAS ATORNILLAR

AKSD08301

COD 0480

PVP: 8,36 €



- Caja plástico
- 1 portapuntas
- Tamaño: PZ0 / PZ1 / PZ2 / PZ3 / PH0 / PH1 / PH2 / PH2 / PH3 / PH4 / SL3 / SL4 / SL5 / SL6 / T10 / T15 / T20 / T25 / T27 / T30 / T40 / H3 / H4 / H5 / H6 / S1 / S2 / S3

EAN 6925582130645 10 unid.

SET 30 PUNTAS ATORNILLAR IMPACTO

AKSD68303

COD 1066

PVP: 11,10 €



- Caja plástico.
- 1 portapuntas.
- Medidas: PH1-2-2-2-3
- SL3-4-5-6-7
- PZ1-2-2-2-3
- T10-15-20-25-27-30-40
- H3-4-5-6
- S1-2-3

EAN 6925582144529 40 unid.

SET IMPACTO VASOS HEXAGONALES 1/4" 6 PCS

AMN65061

COD 1067

PVP: 7,32 €



- Material: 50BV30
- Vasos imantados.
- Hexagonal 1/4"
- Medidas: 6-7-8-9-10-12mm

EAN 6925582137743 50 unid.

JUEGO DE LLAVES ALLEN

HHK11091

COD 0163

PVP: 5,16 €



- 1,5 - 10 mm

EAN 6928073675144 6 unid.
Longitud 180 mm

JUEGO LLAVES ALLEN EXTRA LARGAS

HHK11092

COD 0164

PVP: 6,30 €



- 1,5 - 10 mm

EAN 6928073675151 6 unid.
Longitud 230 mm

JUEGO DE LLAVES ALLEN BOLA

HHK12091

COD 0165

PVP: 6,96 €



- 1,5 - 10 mm

EAN 6928073675168 6 unid.
Longitud 180 mm

JUEGO LLAVES ALLEN BOLA EXTRA LARGAS

HHK12092

COD 0166

PVP: 6,74 €



- 1,5 - 10 mm

EAN 6928073675175 6 unid.
Longitud 230 mm

JUEGO DE LLAVES TORX

HHK13091

COD 0167

PVP: 6,66 €



- T10 - T50

EAN 6925582100358 6 unid.
Longitud 17,5 mm

JUEGO DE LLAVES TORX EXTRA LARGAS

HHK13092

COD 0168

PVP: 7,10 €



- T10 - T50

EAN 6928073675182 6 unid.
Longitud 230 mm

JUEGO DE LLAVES ALLEN COD 0169

HHK14081 PVP: 4,30 €

CrV 8PCS/SET
2mm, 2.5mm, 3mm, 4mm, 5mm, 6mm, 7mm, 8mm



• 2 - 8 mm

EAN 6928073675199 12 unid.

JUEGO DE LLAVES TORX COD 0171

HHK14083 PVP: 4,56 €

CrV 8PCS/SET
T9, T10, T15, T20, T25, T27, T30, T40



• T10 - T40

EAN 6925582100020 12 unid.

JUEGO DE LLAVES ALLEN BOLA MANGO T COD 0173

HHKT80828 PVP: 12,42 €

CrV 8PCS/SET
2X100mm, 2.5X100mm, 3X100mm, 4X150mm, 5X150mm, 6X150mm, 8X200mm, 10X200mm



• 8 Piezas
• 2 - 10 mm

EAN 69411640156730 10 unid.

JUEGO DE LLAVES ALLEN BOLA COD 0170

HHK14082 PVP: 4,56 €

CrV 8PCS/SET
2mm, 2.5mm, 3mm, 4mm, 5mm, 6mm, 7mm, 8mm.



• 2 - 8 mm

EAN 6925582101959 12 unid.

JUEGO DE LLAVES ALLEN MANGO T COD 0172

HHKT80818 PVP: 11,48 €

CrV 8PCS/SET
2X75mm, 2.5X75mm, 3X100mm, 4X100mm, 5X150mm, 6X150mm, 8X200mm, 10X200mm



• 8 Piezas
• 2 - 10 mm

EAN 6941640164414 10 unid.

JUEGO DE LLAVES TORX MANGO T COD 0174

HHKT80838 PVP: 12,60 €

CrV 8PCS/SET
T10X100mm, T15X100mm, T20X100mm, T25X100mm, T30X150mm, T40X150mm, T45X200mm, T50X200mm



• 8 Piezas
• T10 - T50

EAN 6941640166968 10 unid.

LLAVE CARRACA 1/4" COD 0252

HRTH0814 PVP: 6,20 €



EAN	6925582114799	1 unid.
Tamaño	1/4" 45T	
Longitud	158 mm	
Material	CR-V + CR-MO	

LLAVE CARRACA 1/2" 45T COD 0254

HRTH0812 PVP: 11,08 €



EAN	6925582114492	1 unid.
Tamaño	1/2" 45T	
Longitud	260 mm	
Material	CR-V + CR-MO	

LLAVE CARRACA 1/4" - 1/2 COD 0691

HRTH081438 PVP: 9,08 €



• Tamaño 1/4" - 3/8" 72T
• Largo 140 mm
• Material CR-V + CR-MO

EAN	6941640169846	12 unid.
Tamaño	1/4"-3/8" 72T	
Largo	140 mm	
Material	CR-V + Cr-Mo	

LLAVE CARRACA 3/8" COD 0253

HRTH0838 PVP: 8,58 €



EAN	6925582114805	1 unid.
Tamaño	3/8" 45T	
Longitud	205 mm	
Material	CR-V + CR-MO	

LLAVE CARRACA 1/2" 72T COD 0280

HRTH8412 PVP: 12,44 €



EAN	6925582117226	6 unid.
Tamaño	1/2" 72T	
Largo	260 mm	
Material	CR-V + Cr-Mo	

JUEGO DE LLAVES DE AJUSTE RÁPIDO COD 0104

HBWS110808 PVP: 7,46 €

**9-14mm+15-22mm
23-32mm**

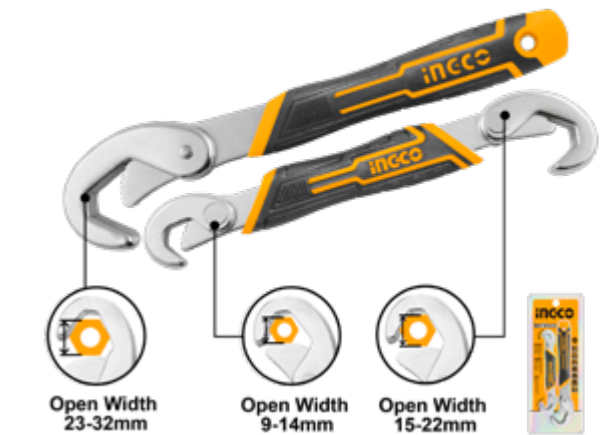

• 9 - 14 mm / 15 - 22 mm / 23 - 32 mm

EAN	6925582113556	5 unid.
-----	---------------	---------

LLAVE AJUSTABLE 2 EN 1



EAN	REF	COD	unid	PVP
6941640174994	HADWS088	0810	48	7,22 €
6941640187468	HADWG0810	0811	24	16,94 €

LLAVE PLANA



Material Cr-v

	EAN	REF	COD	unid	PVP
6x7	6928073677391	HDSPA06071	0812	10	1,02 €
8x9	6928073677407	HDSPA08091	0813	10	1,12 €
10x11	6928073677360	HDSPA10111	0814	10	1,24 €
12x13	6928073677377	HDSPA12131	0815	10	1,30 €
14x15	6928073677384	HDSPA14151	0816	10	1,66 €
16x17	6928073677339	HDSPA16171	0817	10	1,90 €
18x19	6928073677346	HDSPA18191	0818	10	2,18 €
20x22	6928073677353	HDSPA20221	0819	10	2,58 €
21x23	6928073677308	HDSPA21231	0820	10	3,12 €
24x27	6928073677315	HDSPA24271	0821	10	4,30 €
25x28	6928073677322	HDSPA25281	0822	10	5,30 €
30x32	6928073677292	HDSPA30321	0823	10	5,98 €

LLAVE COMBINADA



• Material Cr-v

LLAVE AJUSTABLE



	EAN	REF	COD	unid	PVP
6"	6925582103724	HADW131068	0079	6	6,34 €
8"	6925582103731	HADW131088	0080	6	8,52 €
10"	6925582103700	HADW131108	0081	6	10,66 €
12"	6925582103717	HADW131128	0082	4	14,58 €

LLAVE ACODADA



Material: Cr-v
Cromado, acabado mate

	EAN	REF	COD	unid	PVP
6x7mm 118mm	6928073677278	HOSPA06071	0837	10	1,12 €
8x9mm 137mm	6928073677285	HOSPA08091	0838	10	1,30 €
10x11mm 161mm	6928073677247	HOSPA10111	0839	10	1,42 €
12x13mm 186mm	6928073677254	HOSPA12131	0840	10	1,64 €
14x15mm 213mm	6928073677261	HOSPA14151	0841	10	2,12 €
16x17mm 219mm	6928073677216	HOSPA16171	0842	10	2,48 €
18x19mm 251mm	6928073677223	HOSPA18191	0843	10	2,58 €
20x22mm 270mm	6928073677230	HOSPA20221	0844	10	3,38 €
21x23mm 296mm	6928073677186	HOSPA21231	0845	10	4,14 €
24x27mm 342mm	6928073677193	HOSPA24271	0846	10	5,56 €
25x28mm 342mm	6928073677209	HOSPA25281	0847	10	5,60 €
30x32mm 401mm	6928073677179	HOSPA30321	0848	10	7,26 €

MEDIDA	EAN	REF	COD	unid	PVP
6	6925582116632	HCSPAR061	0824	10	3,36 €
8	6925582111927	HCSPAR081	0825	10	3,36 €
10	6925582111934	HCSPAR101	0826	10	4,00 €
11	6925582111941	HCSPAR111	0827	10	4,13 €
12	6925582111958	HCSPAR121	0828	10	4,45 €
13	6925582111965	HCSPAR131	0829	10	4,78 €
14	6925582111972	HCSPAR141	0830	10	5,09 €
15	6925582111989	HCSPAR151	0831	10	5,35 €
16	6925582111996	HCSPAR161	0881	10	5,61 €
17	6925582112009	HCSPAR171	0832	10	5,76 €
19	6925582112016	HCSPAR191	0833	10	6,50 €
21	6925582112023	HCSPAR211	0834	10	8,42 €
24	6925582112030	HCSPAR241	0835	10	11,04 €
27	6925582112047	HCSPAR271	0836	10	13,24 €

JUEGO DE LLAVES PLANAS 8 PCS

HKSPA2088

COD 0154

PVP: 15,08 €



6x7mm, 8x9mm, 10x11mm, 12x13mm, 14x15mm, 16x17mm, 18x19mm, 20x22mm

EAN	6925582118162	5 unid.
-----	---------------	---------

JUEGO DE LLAVES ACODADAS 8 PCS

HKSPA3088

COD 0155

PVP: 16,14 €



6x7mm, 8x9mm, 10x11mm, 12x13mm, 14x15mm, 16x17mm, 18x19mm, 20x22mm

EAN	6925582118179	5 unid.
-----	---------------	---------

JUEGO DE LLAVES COMBINADAS 8 PCS

HKSPA1088-1

COD 0153

PVP: 13,14 €



6mm, 8mm, 10mm, 13mm, 14mm, 15mm, 17mm, 19mm

EAN	6925582133448	5 unid.
-----	---------------	---------

JUEGO DE LLAVES CARRACA 8 PCS

HKSPAR1082

COD 0156

PVP: 28,58 €



8mm, 10mm, 12mm, 13mm, 14mm, 15mm, 17mm, 19mm

EAN	6925582121230	5 unid.
-----	---------------	---------

JUEGO LLAVES CARRACA ARTICULADA

HKSPAR1083

COD 0624

PVP: 35,74 €



8mm, 10mm, 12mm, 13mm, 14mm, 15mm, 17mm, 19mm

EAN	6925582145977	5 unid.
-----	---------------	---------

JUEGO DE VASOS 12 PCS



MEDIDA	EAN	REF	COD	unid.	PVP
5 - 14 mm	6925582137019	HKTS14122	0481	5	12,74 €
10 - 24 mm	6925582109160	HKTS12122	0157	5	25,41 €



MEDIDA	EAN	REF	COD	Unid.	PVP
8	6928073714232	HHAST12081	0849	10	1,48 €
9	6928073714249	HHAST12091	0850	10	1,48 €
10	6928073714256	HHAST12101	0851	10	1,48 €
11	6928073714263	HHAST12111	0852	10	1,48 €
12	6928073714270	HHAST12121	0853	10	1,48 €
13	6928073714287	HHAST12131	0854	10	1,48 €
14	6928073714294	HHAST12141	0855	10	1,48 €
15	6928073714300	HHAST12151	0856	10	1,48 €
16	6928073714317	HHAST12161	0857	10	1,48 €
17	6925582109139	HHAST12171	0858	10	1,60 €
18	6928073714331	HHAST12181	0859	10	1,78 €
19	6925582109146	HHAST12191	0860	10	1,78 €
20	6928073714355	HHAST12201	0861	10	1,84 €
21	6928073714362	HHAST12211	0862	10	1,84 €
22	6928073714379	HHAST12221	0863	10	2,12 €
23	6925582103199	HHAST12231	0864	10	2,38 €
24	6925582109153	HHAST12241	0865	10	2,38 €
25	6925582103205	HHAST12251	0866	10	2,58 €
26	6925582103212	HHAST12261	0867	10	2,86 €
27	6928073714393	HHAST12271	0868	10	3,06 €
28	6925582103229	HHAST12281	0869	10	3,76 €
29	6925582103236	HHAST12291	0870	10	3,76 €
30	6928073714409	HHAST12301	0871	10	3,98 €
32	6928073714416	HHAST12321	0872	10	4,36 €

RÓTULA 1/2"

COD 0873

HHUJ1121

PVP: 3,86 €



- Material: Cr-v
- 1/2"

EAN 6925582104868 5 unid.

MANGO ARTICULADO 1/2" 375MM

COD 0876

HFXH012151

PVP: 10,86 €

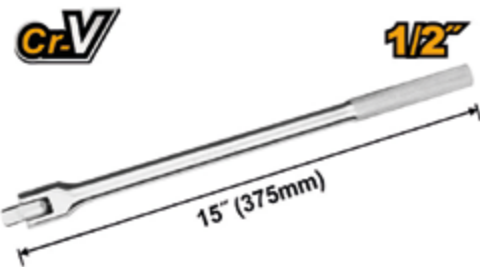

- Material: Cr-v
- 1/2" Longitud: 375mm"

EAN 6925582144000 5 unid.

ALARGADERA 1/2"



- Cr-V 72T
- Cr-V 45T

LONGITUD	EAN	REF	COD	unid	PVP
125mm	6925582104875	HEB12051	0874	5	2,60 €
250mm	6925582104882	HEB12101	0875	5	4,10 €

MANGO CORREDERO 1/2" 250MM

COD 0877

HSTB12101

PVP: 4,70 €

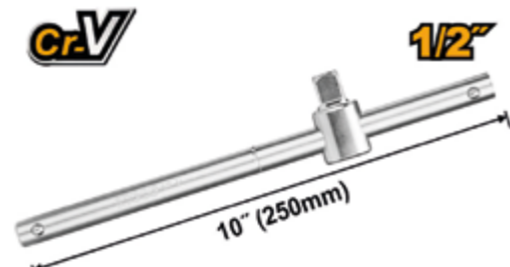

- Material: Cr-v
- 1/2" Longitud: 250mm

EAN 6925582143928 5 unid.

JUEGO VASOS IMPACTO

COD 0608

HKISSD12101

PVP: 19,58 €



- Inserción 1/2" • Largo: 38 mm • 10-12-13-14-15-17-19-21-22-24 mm

EAN 6925582132601 6 unid.

JUEGO VASOS IMPACTO LARGO

COD 0609

HKISSD12102L

PVP: 30,86 €



- Inserción 1/2" • Largo: 78mm • 10-12-13-14-15-17-19-21-22-24 mm

EAN 6925582144628 6 unid.

JUEGO DE LLAVES ACODADAS 12 PCS

COD 0160

HKSPA3142

PVP: 41,38 €



- 6 - 32 mm

EAN 6928073671474 1 unid.

JUEGO DE LLAVES COMBINADAS 12 PCS

COD 0158

HKSPA1143

PVP: 44,02 €



- 6 - 32 mm

EAN 6928073712870 1 unid.

JUEGO DE LLAVES PLANAS 12 PCS

COD 0159

HKSPA2142

PVP: 36,84 €



- 6 - 32 mm

EAN 6928073671467 1 unid.

JUEGO DE LLAVES COMBINADAS 12 PCS

COD 0162

HKSPA1142

PVP: 31,54 €



- 6 - 24 mm

EAN 6928073671450 1 unid.

JUEGO DE LLAVES CARRACA 6 PCS

COD 0161

HKSPAR1061

PVP: 79,30 €



- 19 - 32 mm

EAN 6925582101355 1 unid.

LLAVE STILSON



PULG.	APER.	EAN	REF	COD	unid	PVP
8"	27	6925582115673	HPW0808	0069	10	5,54 €
10"	34	6925582115680	HPW0810	0070	10	7,04 €
12"	42	6925582114232	HPW0812	0071	10	8,58 €
14"	50	6925582115024	HPW0814	0072	10	10,36 €
18"	60	6925582115031	HPW0818	0073	10	14,86 €
24"	76	6925582116533	HPW0824	0074	10	20,98 €
36"	85	6925582116540	HPW0836	0075	10	40,22 €
48"	110	6925582116557	HPW0848	0076	10	54,12 €

CORTAVARILLAS



PULG.	CORTE	EAN	REF	COD	Unid.	PVP
14"	7mm	6925582116779	HBC0814	0403	1	12,08 €
18"	8mm	6925582116786	HBC0818	0404	1	15,64 €
24"	10mm	6925582117097	HBC0824	0405	1	20,70 €
30"	13mm	6925582117103	HBC0830	0406	1	29,18 €
36"	16mm	6925582117349	HBC0836	0407	1	37,58 €
42"	19mm	6925582117356	HBC0842	0408	1	55,04 €
48"	20mm	6925582117615	HBC0848	0409	1	60,36 €

CORTATUBOS PVC

HPCS05428 **COD 0084** PVP: 7,24 €



• Apertura automática

EAN	6925582104820	6 unid.
Cortatubos	3 - 42 mm	
Longitud	193 mm	

LLAVE STILSON AUTOMÁTICA



PULGADAS	EAN	REF	COD	Unid.	PVP
10"	6925582112702	HPW1410	0077	6	10,26 €
14"	6925582112696	HPW1414	0078	4	18,22 €

CORTATUBOS PVC

HPC0535 **COD 1068** PVP: 4,82 €



• Apertura automática

EAN	6928073672167	72 unid.
Cortatubos	3-35mm	
Longitud	210mm	

CORTATUBOS PVC

HPC0442 **COD 0085** PVP: 11,76 €



• Apertura automática

EAN	6928073669501	4 unid.
Cortatubos	3 - 42 mm	
Longitud	225 mm	

CORTATUBOS COBRE

HPC0232 **COD 0086** PVP: 8,08 €



• Cortatubos de cobre y aluminio de 3 - 32 mm

EAN	6928073711071	12 unid.
-----	---------------	----------

TIJERA CHAPA DERECHA

HTSN0110R **COD 0142** PVP: 8,00 €



• Tijera chapa derecha 250 mm

EAN	6928073664438	5 unid.
-----	---------------	---------

TIJERA CHAPA RECTA LARGA

HTSN0112S **COD 0482** PVP: 9,00 €



• Tijera chapa centrada 300 mm.

EAN	6928073672846	5 unid.
-----	---------------	---------

TIJERA CHAPA IZQUIERDA

HTSN0110L **COD 0140** PVP: 8,00 €



• Tijera chapa izquierda 250 mm

EAN	6928073664452	5 unid.
-----	---------------	---------

TIJERA CHAPA

HTSN0110S **COD 0141** PVP: 8,00 €



• Tijera chapa centrada 250 mm

EAN	6928073664445	5 unid.
-----	---------------	---------

JUEGO TIJERAS CHAPA 3 PCS

HTSNK0110 **COD 1069** PVP: 22,90 €



• Tijera chapa derecha, izquierda, centrada. Longitud 250mm

EAN	6925582144475	16 unid.
-----	---------------	----------

ARCO DE SIERRA METÁLICO

HHFS3068

COD 0117

PVP: 4,76 €

ARCO SIERRA METÁLICO

HHF3008

COD 0116

PVP: 9,90 €



• Arco sierra metálico.

EAN	6941640152862		6 unid.
-----	---------------	--	---------



• Arco sierra metálico ajustable

EAN	6928073673348		6 unid.
-----	---------------	--	---------

SIERRA

HMBSB3008

COD 0483

PVP: 5,62 €

SIERRA CON GUÍA

HMBS3008

COD 0118

PVP: 9,64 €



• Hoja de tratamiento térmico.
• Sierra 300 mm

EAN	6925582122831		6 unid.
-----	---------------	--	---------



• Sierra para cortar a inglete 300 mm

EAN	6925582106954		6 unid.
-----	---------------	--	---------

SIERRA COMPÁS

HCS3008

COD 0119

PVP: 4,72 €

SIERRA MURO

HWBSW68

COD 0120

PVP: 6,36 €



• Sierra madera 12" 300 mm

EAN	6925582123944		12 unid.
-----	---------------	--	----------



• Sierra para pladur

EAN	6925582123593		6 unid.
-----	---------------	--	---------

CUTTER MANUAL

HKNS1806

COD 0124

PVP: 0,50 €

CUTTER MANUAL

HKNS16001

COD 0633

PVP: 0,70 €



• Caja de 48 unidades

EAN	6928073672877		48 unid.
Cuchilla			9 x 80 mm
Longitud			129 mm



EAN	6941640156167		12 unid.
Cuchilla			18 x 100 mm
Longitud			152 mm

CUTTER MANUAL

HKNS16518

COD 0121

PVP: 1,62 €

CUTTER MANUAL

HKNS16618

COD 0122

PVP: 1,50 €



EAN	6925582126594		12 unid.
Cuchilla			18 x 100 mm
Longitud			158 mm



• Fijación con ruleta

EAN	6925582128154		12 unid.
Cuchilla			18 x 100 mm
Longitud			158 mm

CUTTER MANUAL

HKNS16538

COD 0123

PVP: 3,04 €

CUTTER MANGO METALICO

HKNS11807

COD 0125

PVP: 2,02 €



• Contiene 3 cuchillas

EAN	6925582127225		12 unid.
Cuchilla			18 x 100 mm
Longitud			169 mm



• Mango metálico

EAN	6941640177094		12 unid.
Cuchilla			18 x 100 mm
Longitud			158 mm

CUTTER MANUAL 3 HOJAS

COD 0692

HKNS28035

PVP: 1,80 €



- Contiene 3 cuchillas

EAN	6941640156464		12 unid.
Cuchilla		18 x 100 mm	
Longitud		162 mm	

CUTTER MANUAL

COD 0127

HUK6128

PVP: 5,02 €



- Incluye 6 cuchillas

EAN	6925582136944		6 unid.
Cuchilla		61 x 19 mm	

CUCHILLA CUTTER

COD 0132

HKNSB112

PVP: 0,50 €



- Pack 10 unidades

EAN	6941640166333		30 unid.
Cuchilla cutter		18 x 100 mm	

CUCHILLA CUTTER

COD 0693

HKNSB0901

PVP: 0,76 €



- Pack 10 unidades

EAN	6941640169235		20 unid.
Cuchilla cutter		9 x 80 mm	

CUTTER MANUAL

COD 0622

HKNS1808

PVP: 6,00 €

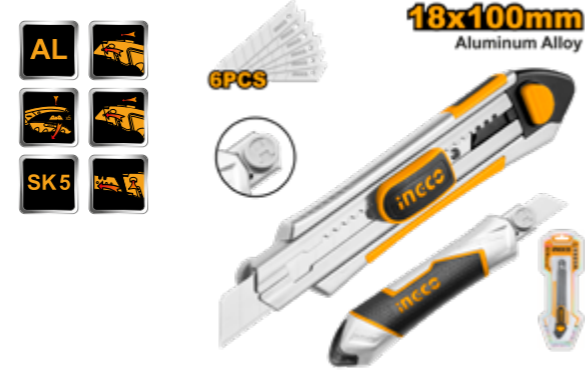

- Estructura aluminio
- Fijación con ruleta
- Contiene 6 cuchillas

- Cuchilla 18 x 100
- Longitud 158 mm

EAN	6925582122619		6 unid.
Cuchilla		61 x 19 mm	

CUTTER 61x19 ALUMINIO

COD 0128

HUK6236

PVP: 6,70 €



- Incluye 6 cuchillas

EAN	6941640164780		6 unid.
Cuchilla		61 x 19 mm	

CUCHILLA CUTTER

COD 0134

HUKB61001

PVP: 0,70 €



- Pack de 10 unidades

EAN	6941640158659		30 unid.
Cuchilla cutter		19 x 61 mm	

CUCHILLO RECTO

COD 0613

HPK82101

PVP: 3,24 €

Straight Blade 200mm(8")



- Cuchilla acero inoxidable
- Longitud 200 mm

EAN	6925582148886		6 unid.
Cuchilla		61 x 19 mm	

ALICATE MULTIUSOS

COD 0137

HFMFT0115

PVP: 15,22 €



EAN	6925582101140		6 unid.
Funciones		15	

RASCADOR METÁLICO CON MANGO

COD 0135

HGS3201

PVP: 5,08 €

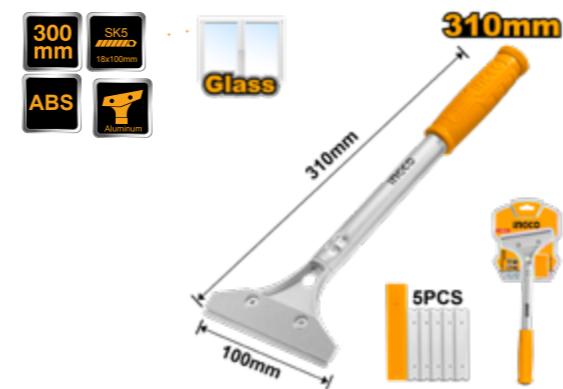

- Rascador metálico
- Utiliza cuchilla cutter 18 x 100 mm

EAN	6941640169075		5 unid.
-----	---------------	--	---------

CUCHILLO CURVO

COD 0614

HPK82001

PVP: 3,24 €

Curved Blade 200mm(8")



- Cuchilla acero inoxidable
- Longitud 200 mm

EAN	6925582148947		6 unid.
Cuchilla		61 x 19 mm	

NAVAJA MULTIUSOS

COD 0136

HMFK8158

Stainless Steel 15 FUNCTION

PVP: 7,16 €



EAN	6925582122404		12 unid.
Funciones		15	

CORTADOR DE CRISTALES

COD 0138

HGCT02

PVP: 2,24 €



- Cortacristales 6 cuchillas

EAN	6925582105407		6 unid.
Longitud		130 mm	

CORTADOR DE CRISTALES

COD 0139

HGCT03

PVP: 3,46 €



- Cortacristales

EAN	6928073671641		6 unid.
Longitud		178 mm	

ESPÁTULA

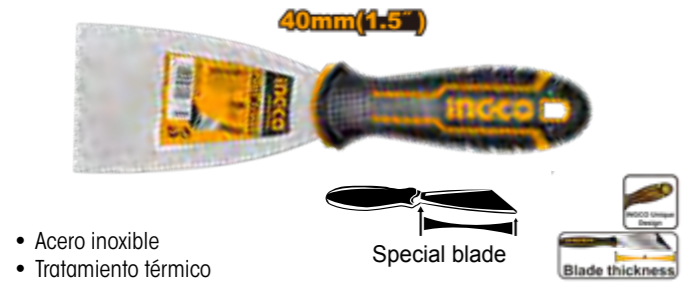

- Acero inoxidable
- Tratamiento térmico

LONGITUD	EAN	REF	COD	unid.	PVP
40 mm	6925582143874	HPUT08040	0623	12	1,76 €
60 mm	6925582106121	HPUT08060	0309	12	1,92 €
80 mm	6925582106138	HPUT08080	0310	12	2,16 €
100 mm	6925582106145	HPUT08100	0311	12	2,38 €
125 mm	6928073683880	HPUT08125	0312	12	2,88 €
150 mm	6925582106152	HPUT08150	0313	12	3,28 €

ESPÁTULA

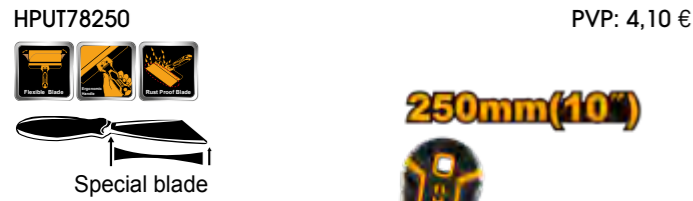

- Escayolista
- Placa de soporte de aluminio
- Mango diseño INGCO

EAN	6941640136213	10 unid.
Tamaño	10" / 250 mm	
Espesor cuchilla	0.5 mm	

CEPILLO DE MANO

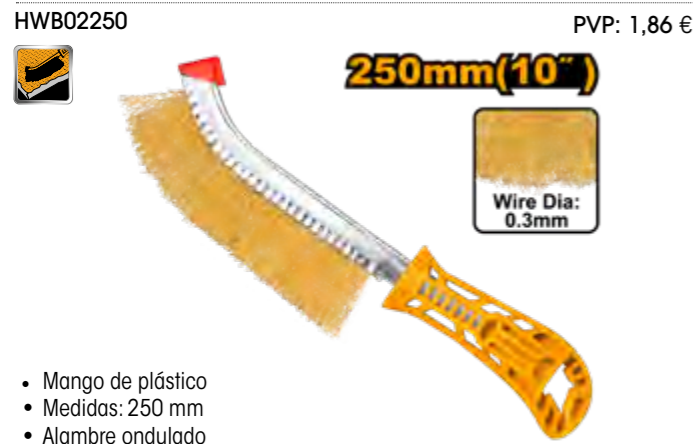

- Mango de plástico
- Medidas: 250 mm
- Alambre ondulado

EAN	6928073669105	15 unid.
-----	---------------	----------

ESPÁTULA



- Escayolista
- Placa de soporte de aluminio
- Mango diseño INGCO

EAN	6941640149008	10 unid.
Medida	8" / 200 mm	
Espesor cuchilla	0.5 mm	

ESPÁTULA MULTIFUNCIÓN



- Acero Inoxidable
- Tratamiento térmico

EAN	6925582127492	12 unid.
Tamaño	60 mm	
Espesor	1,5 mm	

VENTOSA SIMPLE/ DOBLE



MEDIDA	EAN	REF	COD	unid.	PVP
Ø115 mm	6925582129755	HSU012501	0765	12	6,14 €
Ø115 mm	6925582129762	HSU025001	0880	12	11,74 €

ESCUADRA MAGNÉTICA PARA SOLDAR



- Sujeta piezas a 45°, 90° y 135°
- Fuerza de sujeción 11,33 kgf
- Medida 75 mm

EAN	6925582138436	4 unid.
-----	---------------	---------

ESCUADRA MAGNÉTICA PARA SOLDAR



- Sujeta piezas a 45°, 90° y 135°
- Fuerza de sujeción 34,01 kgf
- Medida 125 mm

EAN	6925582138412	4 unid.
-----	---------------	---------

PERFORADOR MANUAL REVÓLVER



- Perforador: 2,5 mm / 3 mm / 3,5 mm / 4 mm / 4,5 mm / 5 mm

EAN	6928073670897	12 unid.
-----	---------------	----------

ESCUADRA MAGNÉTICA PARA SOLDAR



- Sujeta piezas a 45°, 90° y 135°
- Fuerza de sujeción 22,67 kgf
- Medida 100 mm

EAN	6925582138429	4 unid.
-----	---------------	---------

6 PCS ESCUADRA MAGNÉTICA PARA SOLDAR



- Sujeta piezas a 45°, 90° y 135°
- 2 PCS 75 mm Fuerza de sujeción 11,33 kgf
- 4 PCS mini Fuerza de sujeción 4,53 kgf

EAN	6925582150162	4 unid.
-----	---------------	---------

GRAPADORA MANUAL



- Fuerza ajustable
- Admite grapas 11,3 x 0,7 mm y largo 4-14 mm

EAN	6941640169150	6 unid.
-----	---------------	---------

ESCUADRA MAGNÉTICA PARA SOLDAR

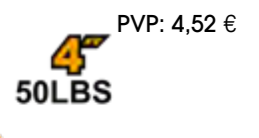

- Sujeta piezas a 45°, 90° y 135°
- Fuerza de sujeción 22,67 kgf
- Medida 100 mm

EAN	6925582138429	4 unid.
-----	---------------	---------

6 PCS ESCUADRA MAGNÉTICA PARA SOLDAR

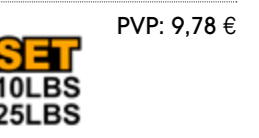

- Sujeta piezas a 45°, 90° y 135°
- 2 PCS 75 mm Fuerza de sujeción 11,33 kgf
- 4 PCS mini Fuerza de sujeción 4,53 kgf

EAN	6925582150162	4 unid.
-----	---------------	---------

GRAPADORA MANUAL



- Fuerza ajustable
- Admite grapas 11,3 x 0,7 mm y largo 4-14 mm

EAN	6941640169150	6 unid.
-----	---------------	---------

PISTOLA SILICONA CREMALLERA
HCG1809 COD 0149
PVP: 2,72 €



- 9" 235 mm
- Cremallera

EAN 6941640189028 12 unid.

PISTOLA SILICONA CREMALLERA
HCG0909 COD 0150
PVP: 6,14 €



- 9" 235 mm
- Cremallera

EAN 6928073680308 12 unid.

PISTOLA SILICONA
HCG1409 COD 0151
PVP: 4,70 €



- 9" 235 mm

EAN 6925582108880 12 unid.

PISTOLA SILICONA
HCG1709 COD 0152
PVP: 8,08 €



- Antigoteo de 9" 235 mm

EAN 6925582104226 12 unid.

PISTOLA MORTERO
HCG0109 COD 0485
PVP: 9,24 €



- Pistola 300 - 9"x235mm

EAN 6928073671894 4 unid.

PISTOLA MORTERO
HCG0115 COD 0148
PVP: 10,96 €



- Pistola 600 - 15"x375 mm

EAN 6928073671900 4 unid.

REMACHADORA
HR101 COD 0111
PVP: 7,50 €



- Remachadora manual acero 10"
- Incluye 3 boquillas adicionales

EAN 6928073661215 6 unid.

REMACHADORA
HR104 COD 0112
PVP: 5,36 €



- Remachadora manual acero 10,5"
- Incluye 3 boquillas adicionales

EAN 6928073680803 6 unid.

REMACHADORA
HR105 COD 0113
PVP: 7,52 €

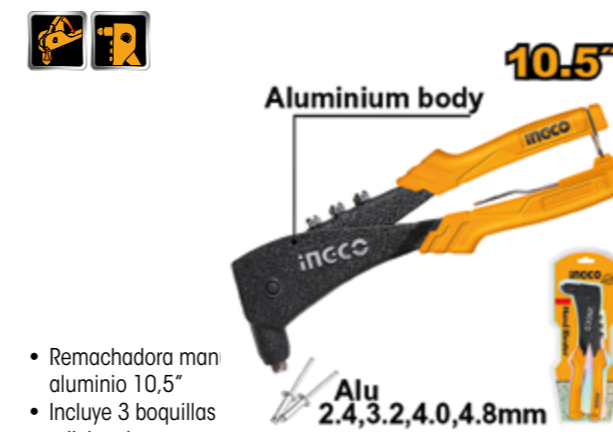

- Remachadora man aluminio 10,5"
- Incluye 3 boquillas adicionales

EAN 6928073684122 6 unid.

REMACHADORA
HR081 COD 0878
PVP: 12,74 €



- Stainless steel: Ø2.4,3.2,4.0mm
- Alu&steel: Ø2.4,3.2,4.0,4.8mm

EAN 6941640156600 12 unid.

REMACHADORA GIRATORIA 360°
SHHR106 COD 0879
PVP: 12,80 €

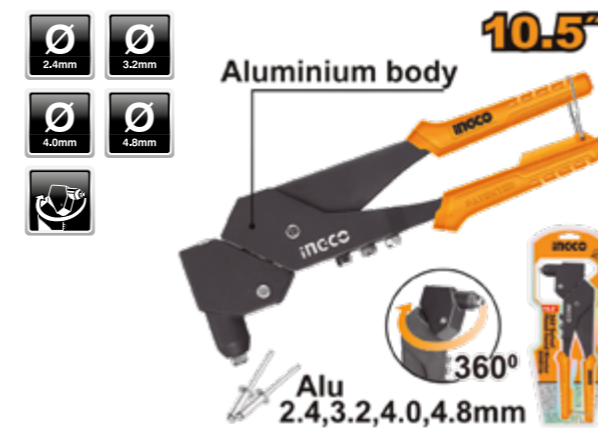

EAN 6925582128079 12 unid.

REMACHADORA DOS MANOS
HR171 COD 0695
PVP: 13,08 €



- Acero aluminizado
- Incluye 3 boquillas adicionales
- Medida 420 mm
- Caja cartón INGCO

EAN 6928073671689 20 unid.

GUANTES PU XL COD 1070
HGPUG01 PVP: 0,82 €



• Palma de poliuretano
EAN 6941640198624 300 unid.

GUANTES LATEX XL COD 1071
HGVL06 PVP: 1,08 €



• Tejido algodón y poliéster sin costuras
• Palma texturizada mejor agarre
EAN 6941640198716 120 unid.

GUANTES XL COD 1075
HGMG02-XL PVP: 13,80 €



• Palma de microfibra con cuero de PVC reforzado
• Goma en la parte posterior
EAN 6925582117820 120 unid.

GUANTES SOLDADOR COD 1076
HGVG01 PVP: 16,60 €



• Medida: 400mm
• Palma y dorso de piel de cabra
• Cuello de buey natural
• Suave y resistente al calor
EAN 6941640198563 96 unid.

GUANTE DE NITRILO TALLA L (9) / XL (10) COD 0191 - 0192
HNGG01 PVP: 1,18 €



• Pack indivisible 12 unid.
EAN 6925582117677 12 unid.
EAN 6925582115192 12 unid.

GUANTES NITRILO XL COD 1072
HGNF03 PVP: 1,84 €



• Palma de nitrilo textura lisa y rugosa.
• Yemas dedos para uso pantalla fácil.
EAN 6941640197627 120 unid.

RODILLERAS COD 1077
HKPT0101 PVP: 16,00 €



• Medida: 215 x 180 mm
• Cubierta exterior de PVC
• Máxima resistencia al impacto
• Cuerpo espuma moldeada, mayor comodidad
• Dos correas elásticas y hebillas flexibles
• Diseño ergonómico
EAN 6941640141941 6 unid.

CHAQUETA IMPERMEABLE L/XL/XXL



TALLA	EAN	REF	COD	Unid.	PVP
L	6925582143539	HJATL2281	0882	1	35,80 €
XL	6925582143669	HJATL2281	0883	1	35,80 €
XXL	6925582143676	HJATL2281	0884	1	35,80 €

GUANTES NITRILO XL COD 1073
HGVN01 PVP: 2,34 €



• Recubiertos totalmente de nitrilo.
EAN 6925582108125 120 unid.

GUANTES RESISTENTES A CORTES XL COD 1074
HGCG02-XL PVP: 3,30 €



• Palma recubierta de PU, flexible
• Material HPPE resistente al corte y abrasión.
• Anti estático
EAN 6941640198686 120 unid.

HERRAMIENTAS DE MEDICIÓN

CATÁLOGO 2024

FLEXÓMETRO BASIC COD 0330
 HSMT08331E PVP: 1,96 €



- Doble botón
- Diseño INGCO

EAN	6925582142747		12 unid.
Largo / ancho	3 m x 16 mm		
Material	ABS		

FLEXÓMETRO BASIC COD 0331
 HSMT083521E PVP: 3,00 €



- Doble botón
- Diseño INGCO

EAN	6925582144956		12 unid.
Largo / ancho	5 m x 19 mm		
Material	ABS		

FLEXÓMETRO BASIC COD 0332
 HSMT08351E PVP: 3,54 €



- Doble botón
- Diseño INGCO

EAN	6925582144949		12 unid.
Largo / ancho	5 m x 25 mm		
Material	ABS		

FLEXÓMETRO PRO COD 0333
 HSMT08031E PVP: 2,64 €



- Autobloqueo
- Doble botón
- Cobertura de goma
- Diseño INGCO

EAN	6925582143843		12 unid.
Largo / ancho	3 m x 16 mm		

FLEXÓMETRO PRO COD 0334
 HSMT080521E PVP: 3,30 €



- Autobloqueo
- Doble botón
- Cobertura de goma
- Diseño INGCO

EAN	6925582143850		12 unid.
Longitud	5 m x 19 mm		

FLEXÓMETRO PRO COD 0335
 HSMT08051E PVP: 3,74 €



- Autobloqueo
- Doble botón
- Cobertura de goma
- Diseño INGCO

EAN	6925582142723		12 unid.
Longitud	5 m x 25 mm		

FLEXÓMETRO PRO COD 0336
 HSMT08081E PVP: 5,44 €



EAN 6925582144932 12 unid.
 Longitud 8 m x 25 mm

FLEXÓMETRO DOBLE CARA COD 0696
 HSMT880521E PVP: 5,62 €



EAN 6941640124456 5 unid.
 • Hoja de nylon • Doble blister
 • Impresión métrica doble cara • Longitud 5m x 19mm
 • Doble gancho de hoja • Diseño INGCO

MEDIDOR LÁSER COD 0176
 HLDD0608 PVP: 66,76 €



EAN 6925582132328 1 unid.
 • 0,05 - 60 m + -1,5 mm • 2 x 1,5 V AAA

FLEXÓMETRO PRO COD 0337
 HSMT08101E PVP: 6,80 €



EAN 6925582142730 6 unid.
 Longitud 10 m x 25 mm

FLEXÓMETRO DOBLE CARA COD 0697
 HSMT88051E PVP: 6,54 €



EAN 6941640123299 5 unid.
 • Hoja de nylon • Doble blister
 • Impresión métrica doble cara • Longitud 5m x 25mm
 • Doble gancho de hoja • Diseño INGCO

NIVEL LASER AUTONIVELANTE COD 0698
 HLL306505E PVP: 143,56 €



EAN 6941640159694 8 unid.
 • Rango de trabajo 0 ~ 30 m • Rango de autonivelación ≤3 °
 • 1 línea horizontal y 4 líneas verticales • Tipo de láser: rojo
 • Precisión de nivelación ± 1,0 mm a 5 m • Clase de láser 3R <5 mW
 • Precisión de línea ± 1,5 mm a 5 m • Con función de bloqueo cruzado
 • Tiempo de nivelación <3 s • Pilas AA (1,5 V) * 4

TRIPODE LASER COD 0699
 HLLT01152 PVP: 32,12 €

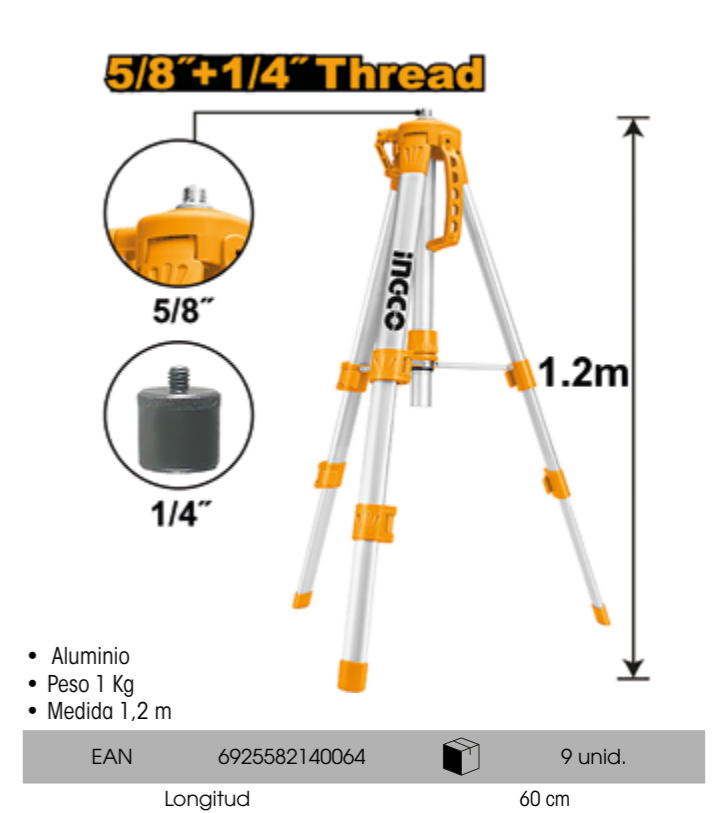

EAN 6925582140064 9 unid.
 Longitud 60 cm
 • Aluminio
 • Peso 1 Kg
 • Medida 1,2 m

NIVEL ANTICHOC COD 0700
 HBSL08040 PVP: 15,84 €



EAN 6941640147134 20 unid.
 Longitud 40 cm

NIVEL ANTICHOC COD 0410
 HBSL08060 PVP: 19,08 €



EAN 6925582122756 20 unid.
 Longitud 60 cm

NIVEL



LONGITUD	EAN	REF	COD	Unid.	PVP
30 cm	6925582112573	HSL08030	0255	20	7,34 €
40 cm	6925582112580	HSL08040	0256	20	8,38 €
60 cm	6925582112597	HSL08060	0273	20	11,86 €
80 cm	6925582110791	HSL08080	0257	20	14,02 €
100 cm	6925582112603	HSL08100	0258	20	16,48 €

NIVEL MAGNÉTICO

- Doble cara fresada
- 0,5 Mm/m viales precisos
- Espesor: 1,5 mm

Powerful Magnets, Unique INCCO Style, Double Flat Surfaces Design, Shock absorbing Rubber End Caps

Imanes	LONGITUD	EAN	REF	COD	unid.	PVP
2	30 cm	6925582126150	HSL38030M	0318	20	10,46 €
2	40 cm	6925582116755	HSL38040M	0319	20	11,36 €
3	60 cm	6925582116731	HSL38060M	0320	20	17,78 €
4	80 cm	6925582116748	HSL38080M	0321	20	18,72 €

NIVEL MAGNÉTICO DIGITAL

HSL08060D **COD 0486** PVP: 72,00 €



- Medidas: 60 cm
- Aviso sonoro a 0°, 45° y 90°
- Lectura temperatura ambiente
- Indicador de batería
- Pantalla LCD con iluminación led
- Botón Mode: Conversión automática porcentaje, grados o pulgadas
- Función recalibrado

EAN 6925582127331 20 unid.

TRANSPORTADOR DE ANGULOS DIGITAL

HDAR20701 **COD 0701** PVP: 18,58 €



- Rango: 180° 0-200mm, 360° 0-400mm
- Lectura 0,05°, 0,1 mm / 0,01"
- Batería 3V
- Conversión de sistema métrico / pulgadas en cualquier posición

EAN 6941640163493 10 unid.

ESCUADRA INOXIDABLE

HAS123002 **COD 0487** PVP: 8,38 €



- Medidas: 300 mm
- Ancho hoja: 40 mm
- Grueso hoja: 1,5 mm
- Hoja de acero inoxidable
- Mango de polímero
- Pulgadas y métrico
- Preparada para marcar diferentes ángulos

EAN 6925582137675 12 unid.

REGLA NIVEL MULTIFUNCIÓN

HSR36003 **COD 0625** PVP: 12,68 €

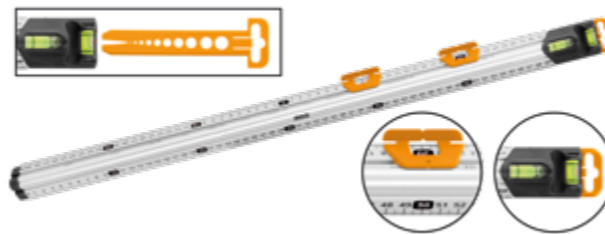

- Estructura aluminio triangular 60 cm
- Función nivel
- Centrar: Escala 0 y con centro marcado
- 2 Marcadores con guía de corte deslizantes
- Pinza extraíble con marcador diámetro brocas
- Escala marcada para enchufes y grifos
- Uña agarre para clavar fácil

EAN 6925582144253 12 unid.

REGLA CON ESCUADRA MAGNÉTICA

HSR530255 **COD 0626** PVP: 35,24 €



- Medida 300 x 25 x 2 mm
- Función nivel
- Ajuste de bloqueo magnético
- Hoja de acero inoxidable
- Angulo 90°, 45°
- Marcador acero inoxidable.

EAN 6925582144260 5 unid.

PIE DE REY DIGITAL PLÁSTICO

HDCP16150 **COD 0489** PVP: 7,04 €



- Material plástico.
- Pantalla LCD.
- Rango: 0-150mm
- Lectura: 0,1 mm
- Batería 3V
- Con guía para medición de profundidad.

EAN 6941640153258 10 unid.

PIE DE REY

HVC01200 **COD 0488** PVP: 22,14 €



- Medidas: 200 mm
- Fabricado en acero al carbono
- Con guía para medición de profundidad
- Caja plástica sólida

EAN 6928073667675 10 unid.

MULTÍMETRO DIGITAL

DM200 **COD 0702** PVP: 20,42 €



- Prueba de diodos
- LCD con retroiluminación
- Voltaje DC 200mV / 2V / 20V / 200V / 600V
- Voltaje CA 200 V / 600 V
- Corriente DC 20mA / 200mA / 10A
- Resistencia 200Ω / 2kΩ / 20kΩ / 200kΩ / 2MΩ / 20MΩ
- Indicación de batería baja
- Apagado automático

EAN 6925582149173 10 unid.

MULTÍMETRO DIGITAL

DM7502

COD 0351

PVP: 37,00 €



- Prueba de diodo
- Luz led incorporada
- Indicador de batería
- Detección de voltaje sin contacto
- 10A ± 1.5% +3
- 10A ± 1.2% +3
- 100mf ± 5.0% + 3
- 60MΩ ± 1.0% + 30
- AC Voltaje: 6V/60V ± 0.8% + 3
- 600V/750V ± 1.0% + 10
- DC Corriente: 60iA/60mA/600mA ± 0.8% + 3
- DC Voltaje: 600mV/6V/60V/600V/1000V ± 0.5% +3
- AC Corriente: 60mA/600mA ± 1.0%+3
- Resistencia: 600Ω/6kΩ/60kΩ/600kΩ/6MΩ ± 0.8% +3
- Capacidad: 6nf ± 4.0% + 30 60nf/600nf/6iF/60iF/600iF/6mf ± 4.0% + 3
- Frecuencia: 9.999Hz/99.99Hz/999.9Hz/9.999KHz/99.99KHz/999.9KHz/9.999M Hz ± 1.0% + 3
- Ciclo de trabajo: 5%-95% ± 2.0% +3)

PINZA AMPERIMÉTRICA

DCM100015

COD 0352

PVP: 44,94 €



- Corriente CA: 60A / 600A / 1000A±(2,5% +8)
- Corriente CC: 60A / 600A / 1000A±(2,5% +8)
- Voltaje CA: 60 mV / 600 mV / 6 V / 60 V / 600 V ± (0,8 % +3) 750 V ± (1 % +4)
- Voltaje CC: 60 mV / 600 mV / 6 V / 60 V / 600 V ± (0,7 % +3) 1000 V ± (0,8 % +2)
- Resistencia: 600Ω / 6kΩ / 60kΩ / 600kΩ / 6MΩ±(0,8% +3) 60MΩ±(1,2% +3)
- Capacitancia: 10nF / 100nF / 1000nF / 10?F / 100?F / 1000?F / 10mF / 100mF±(4,0% +5)
- Temperatura: -20~1000(-8~1832°F)
- Detección de voltaje sin contacto
- Prueba de diodo
- LCD con retroiluminación
- Indicador de batería baja
- Apagado automático
- Con función de luz de flash
- Con 3 pilas AAA LR03

DETECTOR DE CORRIENTE SIN CONTACTO

VD10003

COD 0105

PVP: 8,84 €

DETECTOR DE CORRIENTE 12 - 250 V

HSDT1908

COD 0106

PVP: 1,00 €



EAN 6925582131406 1 unid.

EAN 6925582114928 12 unid.

HERRAMIENTA NEUMÁTICA/ TALLER

CATÁLOGO 2024

MANGUERA NEUMÁTICA

AH1051

COD 0611

PVP: 6,56 €



- Medida 5 m
- Conectores rápidos.
- Resistencia a la flexión y al desgaste

EAN	6928073666210		5 unid.
Presión máxima	12 bar (174 PSI)		

CLAVADORA-GRAPADORA NEUMÁTICA 2 EN 1

ACN50401

COD 0610

PVP: 52,38 €



- Capacidad de carga de 100 unidades
- Tamaño de Brad: 15-50 mm
- Tamaño de la grapa: 16-40 mm
- Ga18, 1.25X1.0mm
- Presión 0.4-0.7Mpa (60-100Psi)
- Contiene 1.000 clavos y 1.000a grapas

EAN	6928073601594		5 unid.
Presión máxima	12 bar (174 PSI)		

PISTOLA DE AIRE

ABG031

COD 0607

PVP: 3,74 €



- Longitud boquilla 16 mm

EAN	6928073600597		25 unid.
-----	---------------	--	----------

MANGUERA NEUMÁTICA

AH1101

COD 0612

PVP: 10,44 €



- Medida 10 m
- Conectores rápidos.
- Resistencia a la flexión y al desgaste

EAN	6928073666227		5 unid.
Presión máxima	12 bar (174 PSI)		

PISTOLA DE INFLADO

ATG0601

COD 0214

PVP: 15,48 €



- Pistola de aire del neumático inflado
- Embalado por ampolla single

EAN	6928073678008		5 unid.
Presión máxima	12 bar (174 PSI)		

PISTOLA DE PETROLEAR

AWG1001

COD 0193

PVP: 12,70 €



- 0,75 l
- Pack indivisible 2 unidades
- 180 l/min

EAN	6925582115215		2 unid.
-----	---------------	--	---------

CONJUNTO DE HERRAMIENTAS DE AIRE 5 PCS

AKT0053

PVP: 36,44 €



- Herramientas de aire

EAN	6941640129802		10 unid.
-----	---------------	--	----------

PISTOLA IMPACTO 3/4"

AIW341301

COD 0195

PVP: 167,38 €



- Reversible

EAN	6925582108361		1 unid.
Velocidades	7.000 rpm		
Consumo de aire	269 l/min		
Máx. torque	1.365 Nm		
Presión de trabajo	6,2 Bar		
Peso	3 Kg		

PISTOLA IMPACTO 1/2"

AIW12562

COD 0194

PVP: 82,40 €



- Reversible

EAN	6925582127010		1 unid.
Velocidades	7.500 rpm		
Consumo de aire	142 l/min		
Máx. torque	567 Nm		
Presión de trabajo	6,2 Bar		
Peso	2,6 Kg		

LLAVE IMPACTO ELÉCTRICA

IW10508

COD 0267

PVP: 133,98 €



- Reversible
- Maleta de plástico

EAN	6925582115208		2 unid.
Velocidades	0 - 2.300 rpm		
Inserción	1/2"		
Máx. torque	550 Nm		

LINTERNAS

CATÁLOGO 2024

LINTERNA LED
HFL013AAA58

COD 0182
PVP: 16,04 €



- 250 lúmenes
- 160m.
- Diámetro: 34mm / 136mm

EAN 6941640183408  36 unid.

LINTERNA LED BATERÍA LION
HCFL186503

COD 0183
PVP: 35,74 €



- 450 lúmenes
- 150m.
- Diámetro: 34mm / 141mm

EAN 6941640178329  36 unid.

LINTERNA FRONTAL
HHL013AAA5

COD 0185
PVP: 13,80 €



- 50 - 150 lúmenes
- IPx4
- ABS
- 4 - 18 horas
- Utiliza 3 unid. AAA - 1,5 V

EAN 6925582122497  6 unid.

LAMPARA TALLER
HWLI35261

COD 0703
PVP: 28,50 €



- Batería recargable de li ion
- 75-300 lúmenes
- Disipación de potencia led 3,5 W
- Incluye cargador usb

EAN 6941640158000  6 unid.

HERRAMIENTA JARDÍN

CATÁLOGO 2024

TRONZADORA PLEGABLE

COD 0186

HFSW1808

PVP: 6,60 €



- 7" 180 mm
- Triple afilado

EAN 6928073673768 6 unid.

SIERRA TRONZADORA

COD 0187

HPS3008

PVP: 8,40 €

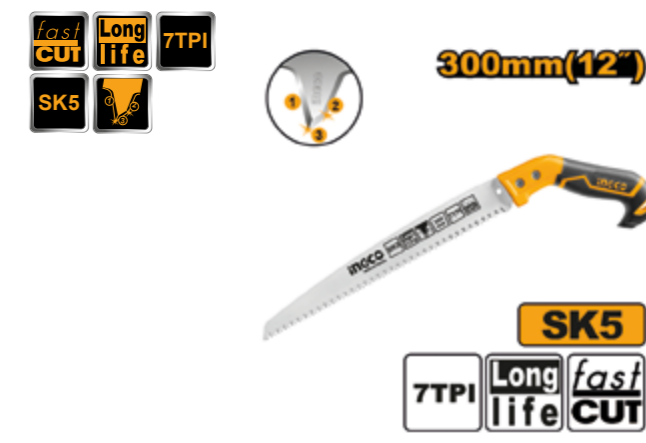

- 12" 300 mm

EAN 6925582123081 6 unid.

SIERRA TRONZADORA

COD 0188

HPS3308

PVP: 8,06 €

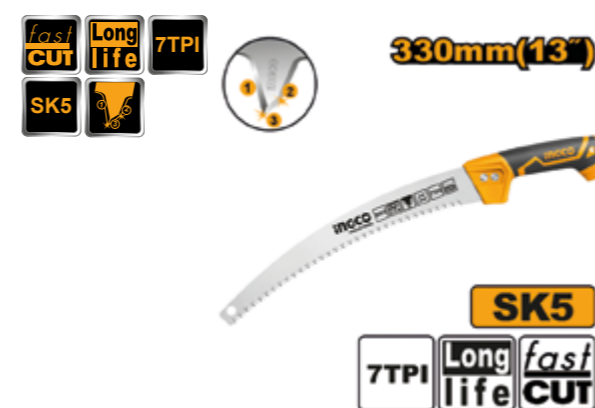

- 13" 330 mm
- Adaptable a alargadera (no incluida)

EAN 6925582123951 6 unid.

ARCO TRONZADOR

COD 0189

HBS6101

PVP: 7,64 €



- 24" 610 mm

EAN 6928073673058 6 unid.

TIJERA CORTASETOS

COD 0261

HHS6001

PVP: 13,96 €



- Material: acero carbono
- Tratamiento térmico

EAN 6928073672211 6 unid.

Longitud 600 mm / 23,5"

TIJERA DE PODAR A DOS MANOS

COD 0262

HHT7101

PVP: 14,36 €



- Material: acero carbono
- Tratamiento térmico

EAN 6928073673102 6 unid.

Longitud 710 mm / 28"

TIJERA DE PODAR A DOS MANOS

HLT7401 COD 0263 PVP: 17,60 €



- Material: Acero carbono
- Tratamiento térmico
- Longitud 740mm / 29"

EAN 69280736737686 unid.

PODADERA COD 0260 CARETA COD 0259

HPS0308 PVP: 10,10 € HFSPC01 PVP: 6,48 €



205mm(8")



MAXφ 14mm



- Cuchilla de alta calidad

EAN 6925582101645 12 unid.
Tamaño 8" / 205 mm



- Pantalla de protección transparente

EAN 6925582112757 20 unid.

PULVERIZADOR 2L COD 1301 PULVERIZADOR 5L COD 1302

HSPP20202 PVP unitario: 6,82 € PVP 10 unidades: 6,20 € PVP 20 unidades: 5,58 € HSPP30502 PVP unitario: 16,48 € PVP 10 unidades: 14,98 € PVP 20 unidades: 13,48 €



2L
2.5Bar



- 2L
- Válvula de liberación de presión de seguridad
- Palanca de bomba de aluminio resistente
- Presión: 2,5 bar
- Función de prensa y liberación
- Boquilla ajustable con chorro recto y nebulización

EAN 6941640190574 20 unid.



5L
2.5Bar



- 5L
- Válvula de liberación de presión de seguridad
- Práctica correa de transporte
- Palanca de bomba de aluminio resistente
- Presión: 2,5 bar
- Manguera flexible de 1,2 m de longitud
- Lanza inoxidable y boquilla de plástico
- Gatillo ON/OFF con bloqueo de gatillo
- Niebla de patrón de rociador ajustable para transmitir

EAN 6941640184535 6 unid.

PULVERIZADOR 8L COD 1304 PULVERIZADOR 16L COD 1305

HSPP30802 PVP unitario: 20,60 € PVP 10 unidades: 18,74 € PVP 20 unidades: 16,86 € HSPP41602 PVP unitario: 33,00 € PVP 10 unidades: 29,98 € PVP 20 unidades: 27,00 €



8L
2.5Bar



- Volumen del tanque: 8L
- Válvula de liberación de presión de seguridad
- Práctica correa de transporte
- Palanca de bomba de aluminio resistente
- Presión: 2,5 bar
- Manguera flexible de 1,2 m de longitud
- Lanza y boquilla de acero inoxidable
- Gatillo ON/OFF con bloqueo de gatillo

EAN 6976051781370 6 unid.



16L
4.5Bar



- 16L
- Gatillo Y con lanza de fibra de vidrio.
- Presión: 4,5 bar
- Boquilla ajustable de chorro a nebulización
- Recipiente grande diseñado específicamente para pulverizar áreas más grandes
- Cómodas correas acolchadas

EAN 6941640182234 6 unid.

HERRAMIENTAS PINTOR

CATÁLOGO 2024

PALETINA MANGO PLÁSTICO



MEDIDAS (ancho x largo x grueso)	EAN	REF	COD	unid	PVP
25 x 45 x 10 mm	6925582126372	CHPTB68701	0490	12	0,66 €
38 x 45 x 11 mm	6925582126419	CHPTB68715	0491	12	0,88 €
50 x 51 x 11 mm	6925582126389	CHPTB68702	0492	12	1,39 €
75 x 57 x 12 mm	6925582126396	CHPTB68703	0493	12	2,56 €
100 x 57 x 14 mm	6925582126402	CHPTB68704	0494	12	3,51 €

PALETINA MANGO FIBRA DE VIDRIO



MEDIDAS (ancho x largo x grueso)	EAN	REF	COD	unid	PVP
25 x 51 x 16 mm	6925582113297	CHPTB8701	0501	12	1,82 €
38 x 51 x 18 mm	6925582114508	CHPTB8715	0502	12	2,24 €
50 x 57 x 18 mm	6925582113303	CHPTB8702	0503	12	3,31 €
63 x 57 x 20 mm	6925582113310	CHPTB8725	0504	12	4,36 €
75 x 64 x 22 mm	6925582113327	CHPTB8703	0505	12	5,98 €
100 x 70 x 22 mm	6925582113334	CHPTB8704	0506	12	8,39 €

RODILLO 100 MM COMPLETO

HRHT061001D

COD 0509

PVP: 2,42 €



- Microfibra
- Mango fibra ergonómico INGCO
- Embalado bolsa plástico

EAN	6925582122244	50 unid.
Medida		100 mm
Largo fibra		12 mm
Varilla		6 mm

PALETINA MANGO FIBRA DE VIDRIO



MEDIDAS (ancho x largo x grueso)	EAN	REF	COD	unid	PVP
25 x 51 x 8 mm	6925582139488	CHPTB8601	0495	12	1,24 €
38 x 51 x 9 mm	6925582139495	CHPTB8615	0496	12	1,57 €
50 x 51 x 10 mm	6925582139501	CHPTB8602	0497	12	2,04 €
63 x 57 x 10 mm	6925582139518	CHPTB8625	0498	12	2,91 €
75 x 57 x 11 mm	6925582139525	CHPTB8603	0499	12	3,46 €
100 x 57 x 12 mm	6925582139532	CHPTB8604	0500	12	4,56 €

RODILLO ESPECIAL ESQUINAS COMPLETO

COD 0507

HRHT360501C

PVP: 3,12 €

- Microfibra
- Mango fibra ergonómico INGCO
- Embalado bolsa plástico



EAN	6925582132847	40 unid.
Medida		50 mm
Largo fibra		8 mm
Varilla		6 mm

RECAMBIO RODILLO ESPECIAL ESQUINAS

COD 0508

HRC3305008

PVP: 1,61 €

- Microfibra
- Embalado bolsa plástico



EAN	6925582135992	100 unid.
Medida		50 mm
Largo fibra		8 mm

RECAMBIO RODILLO 100 MM

COD 0510

HRC3610016

PVP: 0,57 €



- Microfibra
- Embalado bolsa plástico
- Pack indivisible 10 u

EAN	6941640161956	10 unid.
Medida		100 mm
Largo fibra		12 mm

RODILLO 230 MM COMPLETO

HRHT042301D

COD 0511

PVP: 4,61 €



230mm(9")



- Microfibra
- Mango fibra ergonómico INGCO
- Embalado bolsa plástico

EAN	6925582122237		20 unid.
Medida	230 mm		
Largo fibra	12 mm		
Varilla	6 mm		

RECAMBIO RODILLO 230 MM

HRC3323014

COD 0512

PVP: 2,19 €



Micro Fibre

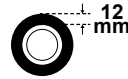

- Microfibra
- Embalado bolsa plástico

EAN	6925582118360		50 unid.
Medida	230 mm		
Largo fibra	12 mm		

RODILLO 230 MM COMPLETO

HRHT042302D

COD 0513

PVP: 5,95 €



230mm(9")



- Microfibra
- Mango fibra ergonómico INGCO
- Embalado bolsa plástico

EAN	6925582122923		20 unid.
Medida	230 mm		
Largo fibra	18 mm		
Varilla	8 mm		

RECAMBIO RODILLO 230 MM

HRC3323018

COD 0514

PVP: 2,61 €



Micro Fibre

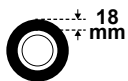

- Microfibra
- Pack indivisible 10 unid.
- Embalado bolsa plástico

EAN	6925582118407		50 unid.
Medida	230 mm		
Largo fibra	18 mm		

RODILLO 255 MM COMPLETO

HRHT092551

COD 0515

PVP: 7,11 €



255mm(10")



- Acrílico
- Mango fibra ergonómico INGCO
- Embalado bolsa plástico

EAN	6925582107050		20 unid.
Medida	255 mm		
Largo fibra	22 mm		
Varilla	8 mm		

RECAMBIO RODILLO 255 MM

HRC0925522

COD 0516

PVP: 4,26 €



Acrylic

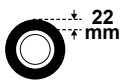

- Acrílico
- Embalado bolsa plástico

EAN	6925582107067		50 unid.
Medida	255 mm		
Largo fibra	22 mm		