

INGCO

Angle Polisher

EN Angle Polisher

ES Pulidora Angular









AP14008 AP14008M UAP14008 UAP14008-9 UAP14008-91 AP14008-2
AP14008S AP14008-6 AP14008-8 AP14008-9 AP14008-2P



SCAN FOR VIDEO



The symbols in instruction manual and the label on the tool

	Double insulated for additional protection.
	Read the instruction manual before using.
	CE conformity.
	Wear safety glasses, hearing protection and dust mask.
	Waste electrical products should not be disposed of with household waste. Please recycle where facilities exist. Check with your Local Authority or retailer for recycling advice.
	Safety alert. Please only use the accessories supported by the manufacture.

GENERAL POWER TOOL SAFETY WARNINGS

⚠ WARNING Read all safety warnings and all instructions. Failure to follow the warnings and instructions may result in electric shock, fire and/or serious injury.

Save all warnings and instructions for future reference.

The term "power tool" in the warnings refers to your mains-operated (corded) power tool or battery-operated (cordless) power tool.

1) Work area safety

- a) **Keep work area clean and well lit.** Cluttered and dark areas invite accidents.
- b) **Do not operate power tools in explosive atmospheres, such as in the presence of flammable liquids, gases or dust.** Power tools create sparks which may ignite the dust or fumes.
- c) **Keep children and bystanders away while operating a power tool.** Distractions can cause you to lose control.

2) Electrical safety

- a) **Power tool plugs must match the outlet. Never modify the plug in any way. Do not use any adapter plugs with earthed (grounded) power tools.** Unmodified plugs and matching outlets will reduce risk of electric shock.
- b) **Avoid body contact with earthed or grounded surfaces such as pipes, radiators, ranges and refrigerators.** There is an increased risk of electric shock if your body is earthed or grounded.
- c) **Do not expose power tools to rain or wet conditions.** Water entering a power tool will increase the risk of electric shock.
- d) **Do not abuse the cord. Never use the cord for carrying, pulling or unplugging the power tool. Keep cord away from heat, oil, sharp edges or moving parts.** Damaged or entangled cords increase the risk of electric shock.
- e) **When operating a power tool outdoors, use an extension cord suitable for outdoor use.** Use of a cord suitable for outdoor use reduces the risk of electric shock.
- f) **If operating a power tools in a damp location is unavoidable, use**

a residual current device (RCD) protected supply. *Use of an RCD reduces the risk of electric shock.*

3) Personal safety

- a) **Stay alert, watch what you are doing and use common sense when operating a power tool. Do not use a power tool while you are tired or under the influence of drugs, alcohol or medication.** *A moment of inattention while operating power tools may result in serious personal injury.*
- b) **Use personal protective equipment. Always wear eye protection.** *Protective equipment such as dust mask, non-skid safety shoes, hard hat, or hearing protection used for appropriate conditions will reduce personal injuries.*
- c) **Prevent unintentional starting. Ensure the switch is in the off-position before connecting to power source and/or battery pack, picking up or carrying the tool.** *Carrying power tools with your finger on the switch or energizing power tools that have the switch on invites accidents.*
- d) **Remove any adjusting key or wrench before turning the power tool on.** *A wrench or a key left attached to a rotating part of the power tool may result in personal injury.*
- e) **Do not overreach. Keep proper footing and balance at all times.** *This enables better control of the power tool in unexpected situations.*
- f) **Dress properly. Do not wear loose clothing or jewellery. Keep your hair, clothing and gloves away from moving parts.** *Loose clothes, jewellery or long hair can be caught in moving parts.*
- g) **If devices are provided for the connection of dust extraction and collection facilities, ensure these are connected and properly used.** *Use of dust collection can reduce dust-related hazards.*

4) Power tool use and care

- a) **Do not force the power tool. Use the correct power tool for your application.** *The correct power tool will do the job better and safer at the rate for which it was designed.*
- b) **Do not use the power tool if the switch does not turn it on and off.** *Any power tool that cannot be controlled with the switch is dangerous*

and must be repaired.

- c) **Disconnect the plug from the power source and/or the battery pack from the power tool before making any adjustments, changing accessories, or storing power tools.** *Such preventive safety measures reduce the risk of starting the power tool accidentally.*
- d) **Store idle power tools out of the reach of children and do not allow persons unfamiliar with the power tool or these instructions to operate the power tool.** *Power tools are dangerous in the hands of untrained users.*
- e) **Maintain power tools. Check for misalignment or binding of moving parts, breakage of parts and any other condition that may affect the power tools operation. If damaged, have the power tool repaired before use.** *Many accidents are caused by poorly maintained power tools.*
- f) **Keep cutting tools sharp and clean.** *Properly maintained cutting tools with sharp cutting edges are less likely to bind and are easier to control.*
- g) **Use the power tool, accessories and tool bits etc. in accordance with these instructions, taking into account the working conditions and the work to be performed.** *Use of the power tool for operations different from those intended could result in a hazardous situation.*

5) Service

- a) **Have your power tool serviced by a qualified repair person using only identical.** *This will ensure that the safety of the power tool is maintained.*

Additional Safety Warnings

Safety instructions for all operations

Safety Warnings Common for Grinding, Sanding, Wire Brushing, Polishing or Abrasive Cutting-Off Operations:

- a) **This power tool is intended to function as a grinder, sander, wire brush, polisher or cut-off tool. Read all safety warnings, instructions and specifications provided with this power tool. Failure to follow all instructions listed below may result in electric shock, fire and/or serious injury.**
- b) **Operations such as grinding, sanding, wire brushing, polishing or cutting-off are not recommended to be performed with this power tool. Operations for which the power tool was not designed may create a hazard and cause personal injury.**
- c) **Do not use accessories which are not specifically designed and recommended by the tool manufacturer. Just because the accessory can be attached to your power tool, it does not assure safe operation.**
- d) **The rated speed of the accessory must be at least equal to the maximum speed marked on the power tool. Accessories running faster than their rated speed can break and fly apart.**
- e) **The outside diameter and the thickness of your accessory must be within the capacity rating of your power tool. Incorrectly sized accessories cannot be adequately guarded or controlled.**
- f) **Threaded mounting of accessories must match the grinder spindle thread. For accessories mounted by flanges, the arbour hole of the accessory must fit the locating diameter of the flange. Accessories that do not match the mounting hardware of the power tool will run out of balance, vibrate excessively and may cause loss of control.**
- g) **Do not use a damaged accessory. Before each use inspect the accessory such as abrasive wheels for chips and cracks, backing pad for cracks, tear or excess wear, wire brush for loose or cracked wires. If power tool or accessory is dropped, inspect for damage or install an undamaged accessory. After inspecting and installing an accessory, position yourself and bystanders away from the plane of the rotating accessory and run the power tool at maximum no-load speed for one minute. Damaged accessories will normally break apart during this test time.**
- h) **Wear personal protective equipment. Depending on application, use face shield, safety goggles or safety glasses. As appropriate, wear dust mask, hearing protectors, gloves and workshop apron capable of stopping small abrasive or workpiece fragments. The eye protection must be capable of stopping flying debris generated by various operations. The dust mask or respirator must be capable of filtrating particles generated by your operation. Prolonged exposure to high intensity noise may cause hearing loss.**
- i) **Keep bystanders a safe distance away from work area. Anyone entering the work area must wear personal protective equipment. Fragments of workpiece or of a broken accessory may fly away and cause injury beyond immediate area of operation.**
- j) **Hold the power tool by insulated gripping surfaces only, when performing an operation where the cutting accessory may contact hidden wiring or its own cord. Cutting accessory contacting a "live" wire may make exposed metal parts of the power tool "live" and could give the operator an electric shock.**
- k) **Position the cord clear of the spinning accessory. If you lose control, the cord may be cut or snagged and your hand or arm may be pulled into the spinning accessory.**
- l) **Never lay the power tool down until the accessory has come to a complete stop. The spinning accessory may grab the surface and pull the power tool out of your control.**
- m) **Do not run the power tool while carrying it at your side. Accidental contact with the spinning accessory could snag your clothing, pulling the accessory into your body.**
- n) **Regularly clean the power tool's air vents. The motor's fan will draw the dust inside the housing**

and excessive accumulation of powdered metal may cause electrical hazards.

- o) Do not operate the power tool near flammable materials. Sparks could ignite these materials.*
- p) Do not use accessories that require liquid coolants. Using water or other liquid coolants may result in electrocution or shock.*

Further safety instructions for all operations

Kickback and Related Warnings

Kickback is a sudden reaction to a pinched or snagged rotating wheel, backing pad, brush or any other accessory. Pinching or snagging causes rapid stalling of the rotating accessory which in turn causes the uncontrolled power tool to be forced in the direction opposite of the accessory's rotation at the point of the binding.

For example, if an abrasive wheel is snagged or pinched by the workpiece, the edge of the wheel that is entering into the pinch point can dig into the surface of the material causing the wheel to climb out or kick out. The wheel may either jump toward or away from the operator, depending on direction of the wheel's movement at the point of pinching. Abrasive wheels may also break under these conditions.

Kickback is the result of power tool misuse and/or incorrect operating procedures or conditions and can be avoided by taking proper precautions as given below.

- a) Maintain a firm grip on the power tool and position your body and arm to allow you to resist kickback forces. Always use auxiliary handle, if provided, for maximum control over kickback or torque reaction during start-up. The operator can control torque reactions or kickback forces, if proper precautions are taken.*
- b) Never place your hand near the rotating accessory. Accessory may kickback over your hand.*
- c) Do not position your body in the area where power tool will move if kickback occurs. Kickback will propel the tool in direction opposite to the wheel's movement at the point of snagging.*
- d) Use special care when working corners, sharp edges etc. Avoid bouncing and snagging the accessory. Corners, sharp edges or bouncing have a tendency to snag the rotating accessory and cause loss of control or kickback.*
- e) Do not attach a saw chain woodcarving blade or toothed saw blade. Such blades create frequent kickback and loss of control.*

Additional safety instructions for grinding and cutting-off operations

Safety Warnings Specific for Grinding and Abrasive Cutting-Off Operations:

- a) Use only wheel types that are recommended for your power tool and the specific guard designed for the selected wheel. Wheels for which the power tool was not designed cannot be adequately guarded and are unsafe.*
- b) The grinding surface of centre depressed wheels must be mounted below the plane of the guard lip. An improperly mounted wheel that projects through the plane of the guard lip cannot be adequately protected.*
- c) The guard must be securely attached to the power tool and positioned for maximum safety, so the least amount of wheel is exposed towards the operator. The guard helps to protect the operator from broken wheel fragments, accidental contact with wheel and sparks that could ignite clothing.*
- d) Wheels must be used only for recommended applications. For example: do not grind with the side of cut-off wheel. Abrasive cut-off wheels are intended for peripheral grinding, side forces applied to these wheels may cause them to shatter.*

e) **Always use undamaged wheel flanges that are of correct size and shape for your selected wheel.** *Proper wheel flanges support the wheel thus reducing the possibility of wheel breakage. Flanges for cut-off wheels may be different from grinding wheel flanges.*

f) **Do not use worn down wheels from larger power tools.** *Wheel intended for larger power tool is not suitable for the higher speed of a smaller tool and may burst.*

Additional safety instructions for cutting-off operations

Additional Safety Warnings Specific for Abrasive Cutting-Off Operations:

a) **Do not “jam” the cut-off wheel or apply excessive pressure. Do not attempt to make an excessive depth of cut.** *Overstressing the wheel increases the loading and susceptibility to twisting or binding of the wheel in the cut and the possibility of kickback or wheel breakage.*

b) **Do not position your body in line with and behind the rotating wheel.** *When the wheel, at the point of operation, is moving away from your body, the possible kickback may propel the spinning wheel and the power tool directly at you.*

c) **When wheel is binding or when interrupting a cut for any reason, switch off the power tool and hold the power tool motionless until the wheel comes to a complete stop. Never attempt to remove the cut-off wheel from the cut while the wheel is in motion otherwise kickback may occur.** *Investigate and take corrective action to eliminate the cause of wheel binding.*

d) **Do not restart the cutting operation in the workpiece. Let the wheel reach full speed and carefully re-enter the cut.** *The wheel may bind, walk up or kickback if the power tool is restarted in the workpiece.*

e) **Support panels or any oversized workpiece to minimize the risk of wheel pinching and kickback.** *Large workpieces tend to sag under their own weight. Supports must be placed under the workpiece near the line of cut and near the edge of the workpiece on both sides of the wheel.*

f) **Use extra caution when making a “pocket cut” into existing walls or other blind areas.** *The protruding wheel may cut gas or water pipes, electrical wiring or objects that can cause kickback.*

Additional safety instructions for sanding operations

Safety Warnings Specific for Sanding Operations:

a) **Do not use excessively oversized sanding disc paper. Follow manufacturers recommendations, when selecting sanding paper.** *Larger sanding paper extending beyond the sanding pad presents a laceration hazard and may cause snagging, tearing of the disc or kickback.*

Additional safety instructions for polishing operations

Safety Warnings Specific for Polishing Operations:

a) **Do not allow any loose portion of the polishing bonnet or its attachment strings to spin freely. Tuck away or trim any loose attachment strings.** *Loose and spinning attachment strings can entangle your fingers or snag on the workpiece.*

Additional safety instructions for wire brushing operations

Safety Warnings Specific for Wire Brushing Operations:

a) **Be aware that wire bristles are thrown by the brush even during ordinary operation. Do not overstress the wires by applying excessive load to the brush.** *The wire bristles can easily penetrate light clothing and/or skin.*

b) **If the use of a guard is recommended for wire brushing, do not allow any interference of the wire wheel or brush with the guard.** *Wire wheel or brush may expand in diameter due to work load and centrifugal forces.*

Residual risks

Even when the power tool is used as prescribed it is not possible to eliminate all residual risk factors. The following hazards may arise in connection with the power tool's construction and design:

- a) Health defects resulting from vibration emission if the power tool is being used over longer period of time or not adequately managed and properly maintained.
- b) Injuries and damage to property to due to broken accessories that are suddenly dashed.



Warning! This power tool produces an electromagnetic field during operation. This field may under some circumstances interfere with active or passive medical implants. To reduce the risk of serious or fatal injury, we recommend persons with medical implants to consult their physician and the medical implant manufacturer before operating this power tool.

Technical Data

Model No:	AP14008 AP14008-2P	AP14008M	AP14008-2	AP14008-6 (ISREAL Plug)	AP14008-8 (BS Plug)	AP14008-9 (INMENTRO Plug)	AP14008S (SAA Plug)	UAP14008
Rated input power	1400W							1400W
Rated voltage	220-240V~50/60Hz							110-120V~50/60Hz
No-load speed	1500-4500/min							1500-4500/min
Disc diameter	180mm							7"
Weight	3.5Kg							3.5Kg
Insulation class	□ [double-insulated]							□ [double-insulated]

Model No:	UAP14008-9	UAP14008-91
Rated input power	1400W	1400W
Rated voltage	127V~60Hz	127V~60Hz
No-load speed	1500-4500/min	1500-4500/min
Disc diameter	7"	7"
Weight	3.5Kg	3.5Kg
Insulation class	□ [double-insulated]	□ [double-insulated]

IMPORTANT!

When using electrical tools, always observe the following basic safety rules.

Safe operation of the machine requires that you read the operating manual and safety instructions and comply with them before using the machine for the first time. You should also observe general safety rules. You may wish to have a professional demonstrate for you how to operate the machine before you use it.

- Always use safety goggles
- Wear work clothing and gloves
- Use a dust mask
- Secure the item to be drilled to prevent it from rotating.
- Always switch the machine off when placing the polishing wheel / steel brush.
- It is advisable to always use the support handle provided
- Remember to always stand on a stable surface.
- Never use the machine under the influence of alcohol, medicine or similar substances
- Never use the machine when children are nearby.
- Protect the machine from humidity.
- Always store the tool out of the reach of children.
- Never overload the machine.
- Check regularly that all screws are tightened
- Never use your hands to secure the item while you are drilling.
- Keep fingers and the like away come close to the rotating parts
- Check that the power supply is 220-240V~50/60Hz or 110-120V/60Hz [Incorrect voltage will damage the machine and the warranty will become null.]
- Replace or repair defective Ledninger omgaende

Unpacking the Machine

Carefully remove the machine from its packaging check that you have removed all parts from the packaging

Description of the Machine

1. Switch
2. Auxiliary handle
3. Spindle lock
4. Wool polishing bonnet & polishing pad
5. Speed control



Using the Machine

- Connect the machine to 220-240V~50/60Hz or 110-120V~50/60Hz in the wall outlet
- Hold the machine with both hands
- Press the power switch (1)
- Always let the machine run for a moment to check that the wheel firmly attached
- Carefully lower the machine onto the item and hold at a 15° angle

Replacing polishing wheel/steel brush discs

- Cut off the machine's power by removing the plug from the wall socket
- Press and hold in the spindle (3)
- The polishing wheel should be centered on the disc after replacement
- After replacement always run the machine for 1 mi to ensure that the disc/brush is firmly attached

INGCO

EXPLODED VIEW

AP14008, AP14008M, UAP14008, AP14008-2, AP14008-6, AP14008-8, AP14008-9, AP14008S, AP14008-2P
UAP14008-9, UAP14008-91

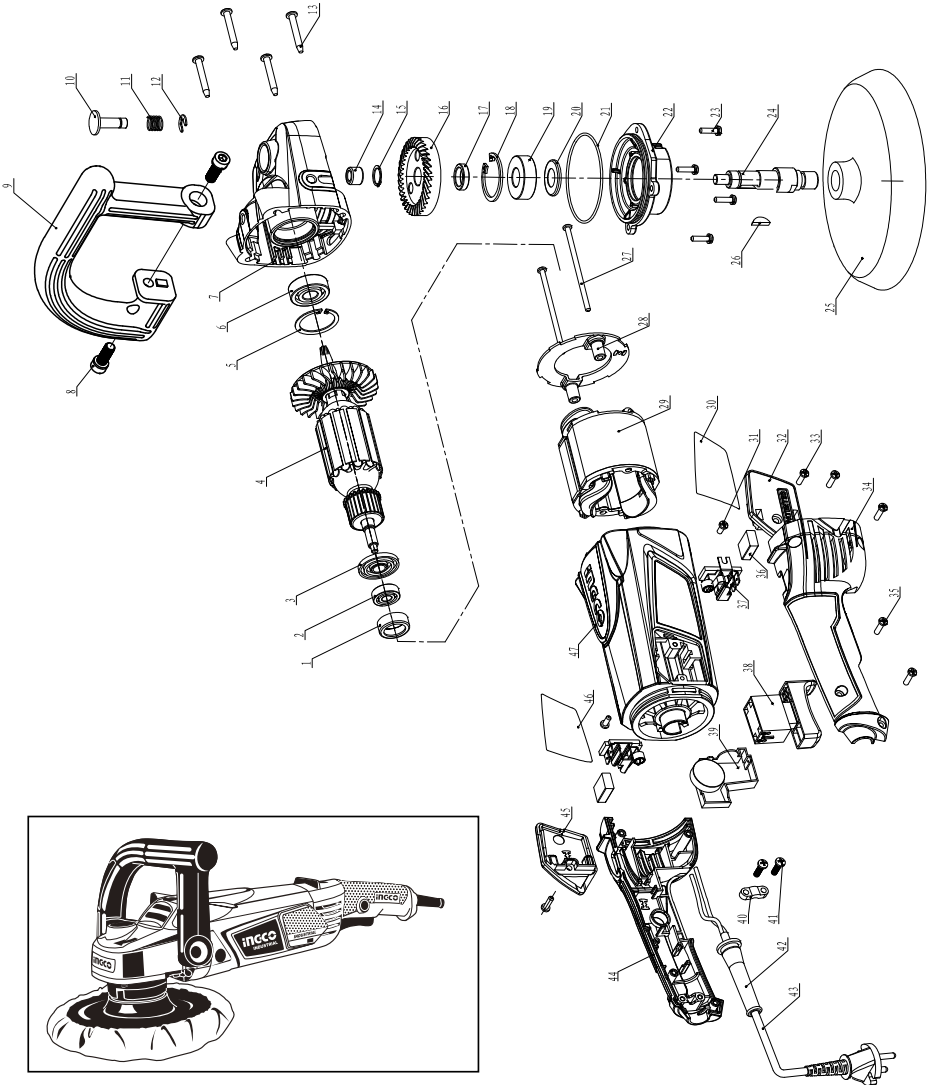



SPARE PART LIST

AP14008,AP14008M,UAP14008,AP14008-2,AP14008-6,AP14008-8,AP14008-9,AP14008S,AP14008-2P
UAP14008-9,UAP14008-91

No.	Exploding view	Qty
1	Bearing Sheath	1
2	Bearing	1
3	Spring	1
4	Rotor	1
5	Pin	1
6	6201 Bearing	1
7	Reduction Gear Box	1
8	M8*20 screw	2
9	side handle	1
10	Lock Pin	1
11	Spring	1
12	spring	1
13	ST5*35 screw	4
14	Needle bearing	1
15	circlip	1
16	Large Bevel Gear	1
17	Steel Pipe	1
18	screw	1
19	6202 Bearing	1
20	Dustproof Cover	1
21	O-Ring	1
22	Circlips for hole	1
23	M4*16 screw	4
24	Main Spindle	1

No.	Exploding view	Qty
25	sander plate	1
26	Gear shaft	1
27	ST4*80 screw	1
28	Wind Screen	1
29	Stator	1
30	Brand	1
31	ST4*10 screw	2
32	Right Brush Cover	1
33	ST4*12 screw	2
34	Right Handle	1
35	ST4*16 screw	4
36	Brush	2
37	Brush Holder	2
38	Switch	1
39	Speed control	1
40	Cord clamp	1
41	ST4*14 screw	2
42	Cord protector	1
43	Plug & Cord	1
44	Left Handle	1
45	Left Brush Cover	1
46	Nameplate	1
47	housing	1

Datos técnicos

Modelo No	AP14008 AP14008-2P	AP14008M	AP14008-2	AP14008-6 (ISREAL Plug)	AP14008-8 (BS Plug)	AP14008-9 (INMETRO Plug)	AP14008S (SAA Plug)	UAP14008
Potencia nominal de entrada	1400W							1400W
Tensión nominal	220-240V-50/60Hz							110-120V-50/60Hz
Velocidad sin carga	1500-4500/min							1500-4500/min
Diámetro de la almohadilla de pulido	180mm							7"
Peso	3.5Kg							3.5Kg
Clase de aislamiento	☐ [double-insulated]							☐ [double-insulated]

Modelo No	UAP14008-9	UAP14008-91
Potencia nominal de entrada	1400W	1400W
Tensión nominal	127V-60Hz	127V-60Hz
Velocidad sin carga	1500-4500/min	1500-4500/min
Diámetro de la almohadilla de pulido	7"	7"
Peso	3.5Kg	3.5Kg
Clase de aislamiento	☐ [double-insulated]	☐ [double-insulated]

Instrucciones de seguridad

Gracias por su confianza en la elección de esta máquina. Para lograr los mejores resultados, lea atentamente este manual antes de usar la máquina por primera vez.

Siempre guarde el manual junto con la máquina.

¡IMPORTANTE!

Al utilizar herramientas eléctricas es conveniente siempre seguir las siguientes reglas básicas de seguridad.

La operación segura de la máquina requiere que usted lea el manual de instrucciones de funcionamiento y de seguridad antes de usar la máquina por primera vez y cumpla con ellas. También debe observar las reglas generales de seguridad. Puede que desee tener un profesional para que demuestre la forma de operar la máquina antes de usarla.

- Siempre utilice gafas de seguridad
- Use ropa de trabajo y guantes
- Use una máscara contra el polvo
- Asegure el elemento a ser perforado para evitar que gire.
- Siempre apague la máquina cuando quiera sustituir la rueda de pulir / cepillo de acero.
- Es recomendable utilizar siempre el mango de apoyo.
- Recuerde que se debe siempre estar parado sobre una superficie estable.
- Nunca use la máquina bajo la influencia del alcohol, medicamentos o sustancias similares.
- No utilice nunca la máquina cuando haya niños cerca.
- Proteja la máquina de la humedad.
- Siempre guarde las herramientas fuera de alcance de los niños.
- No sobrecargue la máquina.
- Compruebe con regularidad que todos los tornillos estén bien apretados.
- Nunca use las manos para asegurar el elemento mientras se está perforando.
- Mantenga los dedos alejados de las piezas giratorias.
- Compruebe que la fuente de alimentación es 220-240/110-120V. (una incorrecta tensión puede dañar la máquina, y la garantía será nula)
- Reemplace o repare dispositivos y accesorios defectuosos

Desembalaje de la máquina

Retire con cuidado la máquina de su embalaje y compruebe que haya retirado todas las piezas del embalaje.

Descripción de la máquina

1. El interruptor de encendido desactiva la energía cuando se le libera
2. Soporte del manillar
3. Bloqueo del eje
4. Disco de pulido
5. Interruptor de encendido y el botón para ajustar el paso



Uso de la máquina

- Conecte el aparato a la toma de corriente
- Sostenga la máquina con las dos manos
- Presione el interruptor de encendido (1)
- Siempre haga funcionar el aparato libremente por un momento para comprobar que la rueda está firmemente ajustada
- Baje con cuidado la máquina a la superficie y sosténgala a un ángulo de 15

Sustitución de la rueda de pulido / cepillo de acero

- Corte la energía eléctrica de la máquina quitando el enchufe de la toma de corriente
- Presione y mantenga el seguro (3)
- Desenrosque el disco / cepillo (4)
- La rueda de pulido debe estar centrada en el disco después de ser reemplazada
- Después de la sustitución, siempre haga funcionar la máquina durante un minuto para asegurarse de que el disco / cepillo esté firmemente ajustado

Mantenimiento

Desenchufe la toma de corriente cuando la máquina no esté en uso.

La máquina está diseñada para operar sin problemas por un largo período de tiempo con mínimo mantenimiento. La limpieza regular de la máquina con y su uso correcto, prolonga la vida útil de la máquina.

Limpie la máquina con regularidad.

Protección ambiental

Los materiales utilizados deben ser reciclados en lugar de ser depositados como residuo.

Cuando el producto esté desgastado, hay que proteger la naturaleza y no desecharlo en la basura regular. Es prudente reciclar el producto, sus accesorios y su empaque de una manera amistosa con el ambiente. Deseche el producto a través de un agente local de recolección de residuos o taller de servicio.

INGCO

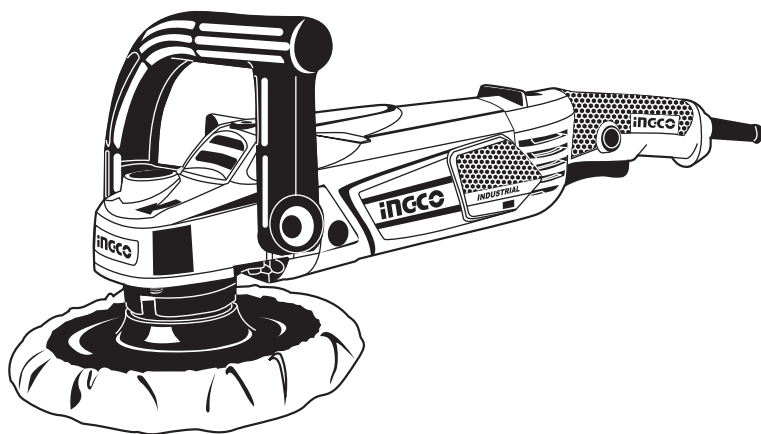

INGCO TOOLS CO., LIMITED

www.ingco.com

MADE IN CHINA

0919.V11

**AP14008 AP14008M UAP14008 AP14008-2 UAP14008-9 UAP14008-91
AP14008S AP14008-6 AP14008-8 AP14008-9 AP14008-2P**